









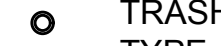

LEGEND

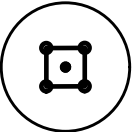
-  BENCH
-  TABLE
-  TRASH RECEPTACLE TYPE A
-  TRASH RECEPTACLE TYPE B
-  BICYCLE PARKING POST
-  EXISTING SMALL TREE WITH TREE PROTECTION (< 4" CAL.)
-  EXISTING LARGE TREE WITH TREE PROTECTION
-  PROPOSED DECIDUOUS SHADE TREE
-  PROPOSED ORNAMENTAL TREE
-  PROPOSED EVERGREEN TREE
-  PROPOSED SHRUBS
-  PROPOSED PERENNIALS, ORNAMENTAL GRASSES, & GROUNDCOVERS
-  LAWN

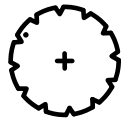
SHEET 1 PLANT LIST

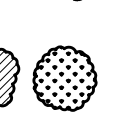
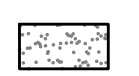
SYM	QTY	BOTANICAL NAME	COMMON NAME	SIZE	ROOT	COMMENTS
DECIDUOUS SHADE TREES						
AR	2	<i>Acer rubrum</i> 'October Glory'	October Glory Red Maple	2.5-3" cal.	B&B	Limb to 7' ht.
GT	2	<i>Gleditsia triacanthos</i> v. <i>inermis</i> 'Skyline'	Skyline Honeylocust	2.5-3" cal.	B&B	Limb to 7' ht.
QA	2	<i>Quercus alba</i>	White Oak	2.5-3" cal.	B&B	Limb to 7' ht.

PLANTING NOTES

1. CONTRACTOR SHALL HAVE ALL SUBSURFACE UTILITIES MARKED PRIOR TO THE START OF WORK.
2. PLANT LOCATIONS ARE APPROXIMATE. ALL PROPOSED TREE LOCATIONS SHALL BE STAKED OR LAID OUT IN THEIR APPROXIMATE LOCATION BY THE CONTRACTOR. THE CONTRACTOR SHALL ADJUST THE LOCATIONS AS REQUESTED BY THE CITY'S LANDSCAPE ARCHITECT CONSULTANT TO ACCOUNT FOR SUBSURFACE UTILITIES AND OTHER FIELD CONDITIONS. PRIOR TO PLANTING. LOCATION OF ALL PLANT MATERIAL WILL BE APPROVED BY THE RESIDENT ENGINEER AND THE CITY'S LANDSCAPE ARCHITECT CONSULTANT.
3. ALL PLANT MATERIAL WILL HAVE TAGS INDICATING COMMON NAME, BOTANICAL NAME, CULTIVAR, & SIZE.
4. IMMEDIATELY AFTER ACCEPTANCE OF PLANTING, TAGS AND RIBBONS SHALL BE REMOVED.
5. ALL PLANTS WILL BE MULCHED PER PLANS AND SPECIFICATIONS.
6. ALL SHRUB AND PERENNIAL BEDS WILL BE WEDED AND OTHERWISE NEATLY MAINTAINED FOR THE DURATION OF THE CONTRACT.
7. PLANTS AND PLANTING BEDS SHALL BE THOROUGHLY WATERED AS NECESSARY AND PER SPECIFICATIONS.
8. PROPOSED TRAFFIC SIGNAL EQUIPMENT HAS BEEN SHOWN IN GREY FOR CLARITY.







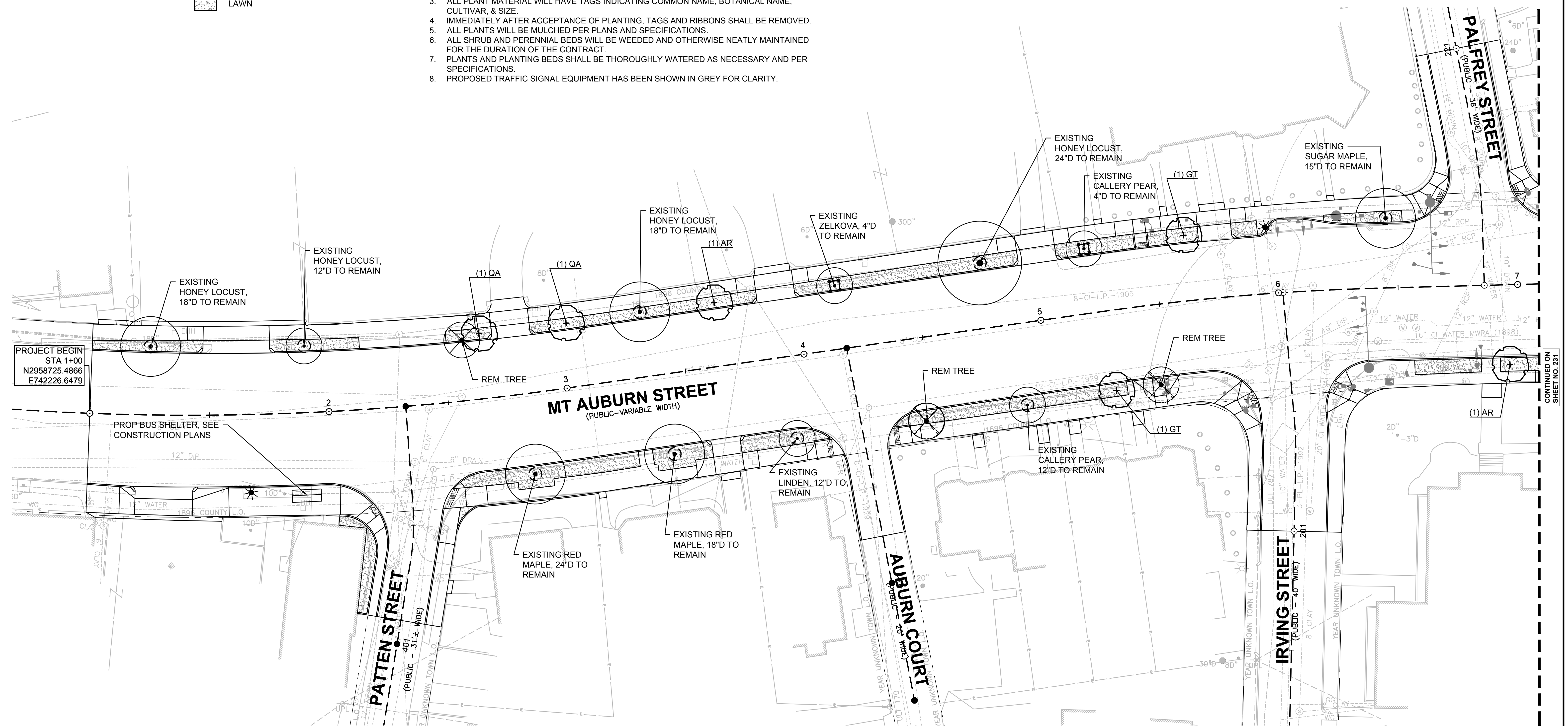
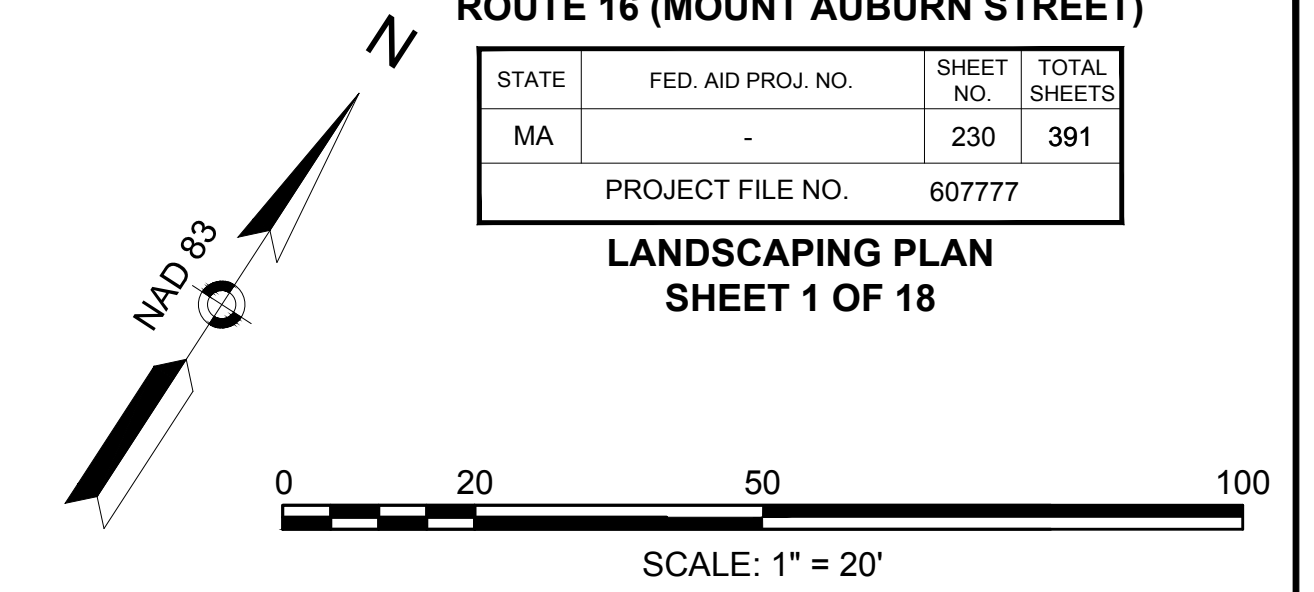



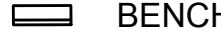

**WATERTOWN
ROUTE 16 (MOUNT AUBURN STREET)**

STATE	FED. AID PROJ. NO.	SHEET NO.	TOTAL SHEETS
MA	-	230	391

**LANDSCAPE PLAN
SHEET 1 OF 18**

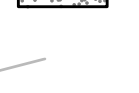

LEGEND

-  BENCH
-  TABLE
-  TRASH RECEPTACLE TYPE A
-  TRASH RECEPTACLE TYPE B
-  BICYCLE PARKING POST
-  EXISTING SMALL TREE WITH TREE PROTECTION (< 4" CAL.)
-  EXISTING LARGE TREE WITH TREE PROTECTION
-  PROPOSED DECIDUOUS SHADE TREE
-  PROPOSED ORNAMENTAL TREE
-  PROPOSED EVERGREEN TREE
-  PROPOSED SHRUBS
-  PROPOSED PERENNIALS, ORNAMENTAL GRASSES, & GROUNDCOVERS
-  LAWN

SHEET 2 PLANT LIST

SYM	QTY	BOTANICAL NAME	COMMON NAME	SIZE	ROOT	COMMENTS
DECIDUOUS SHADE TREES						
AR	1	<i>Acer rubrum</i> 'October Glory'	October Glory Red Maple	2.5-3" cal.	B&B	Limb to 7' ht.
GB	3	<i>Ginkgo biloba</i> 'Princeton Sentry'	Princeton Sentry Maidenhair Tree	2.5-3" cal.	B&B	Limb to 7' ht.
QP	2	<i>Quercus palustris</i>	Pin Oak	2.5-3" cal.	B&B	Limb to 7' ht.
ORNAMENTAL TREES						
AL	1	<i>Amelanchier laevis</i> 'Snowcloud'	Snowcloud Serviceberry	2.5-3" cal.	B&B	Single Stem
BN	2	<i>Betula nigra</i> 'Heritage'	Heritage River Birch	2.5-3" cal.	B&B	Single Stem
SR	3	<i>Syringa reticulata</i> 'Ivory Silk'	Ivory Silk Japanese Tree Lilac	2.5-3" cal.	B&B	Single Stem
SHRUBS						
RA	56	<i>Rhus aromatica</i> 'Gro-Low'	Gro-Low Fragrant Sumac	2 gal.	CONT.	30" O.C. Spacing
PERENNIALS, ORNAMENTAL GRASSES & GROUNDCOVERS						
VM	228	<i>Vinca minor</i> 'Bowles'	Bowles Periwinkle	4" pot	CONT.	12" O.C. Spacing

NOTES:

1. FOR PLANTING NOTES, REFER TO SHEET 230.
2. FOR MASTER PLANT LIST, REFER TO SHEET 256.
3. FOR LANDSCAPING DETAILS, REFER TO SHEETS 254-256.

**WATERTOWN
ROUTE 16 (MOUNT AUBURN STREET)**

STATE	FED. AID PROJ. NO.	SHEET NO.	TOTAL SHEETS
MA	-	231	391
PROJECT FILE NO.		607777	



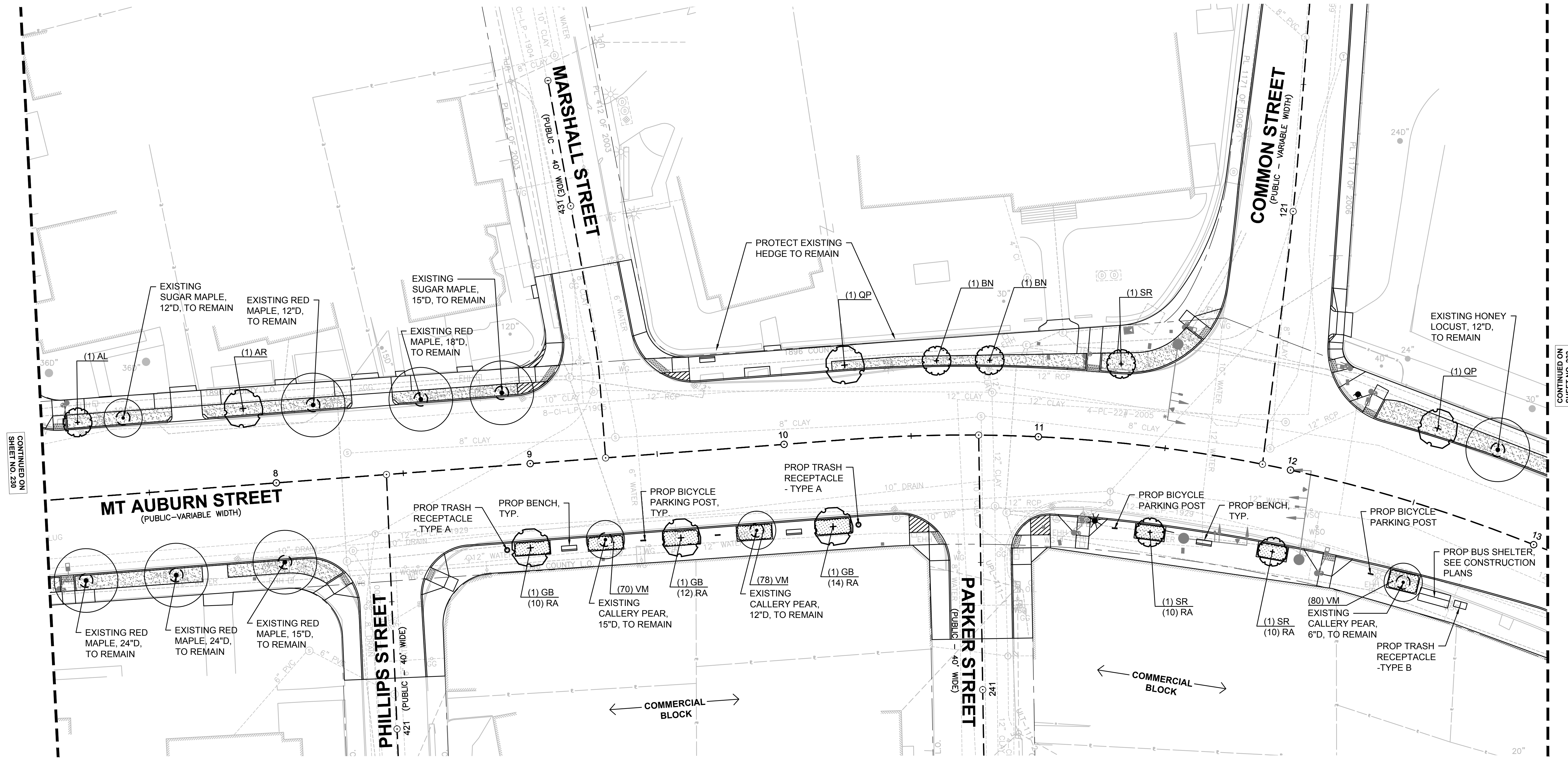
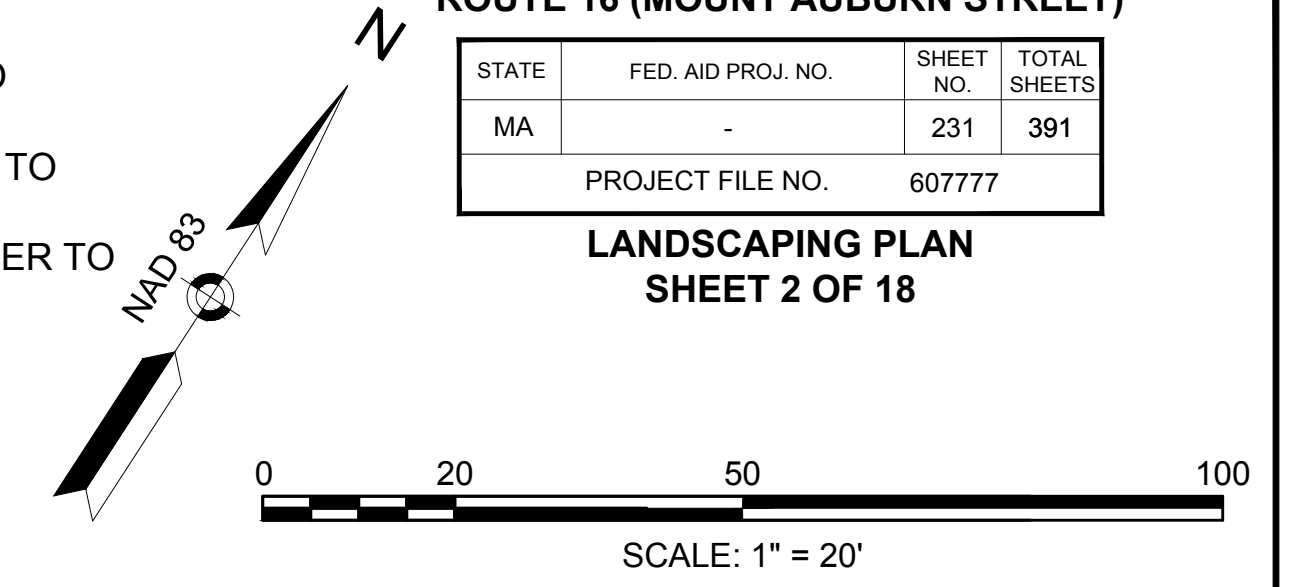







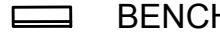

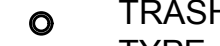
**LANDSCAPING PLAN
SHEET 2 OF 18**



CONTINUED ON SHEET NO. 230

CONTINUED ON SHEET NO. 232

LEGEND

-  BENCH
-  TABLE
-  TRASH RECEPTACLE TYPE A
-  TRASH RECEPTACLE TYPE B
-  BICYCLE PARKING POST
-  EXISTING SMALL TREE WITH TREE PROTECTION (< 4" CAL.)
-  EXISTING LARGE TREE WITH TREE PROTECTION
-  PROPOSED DECIDUOUS SHADE TREE
-  PROPOSED ORNAMENTAL TREE
-  PROPOSED EVERGREEN TREE
-  PROPOSED SHRUBS
-  PROPOSED PERENNIALS, ORNAMENTAL GRASSES, & GROUNDCOVERS
-  LAWN

SHEET 3 PLANT LIST

SYM	QTY	BOTANICAL NAME	COMMON NAME	SIZE	ROOT	COMMENTS
DECIDUOUS SHADE TREES						
LT	4	Liriodendron tulipifera 'Emerald City'	Emerald City Tulip Tree	2.5-3" cal.	B&B	Limb to 7' ht.
PA	1	Platanus x acerifolia 'Exclamation'	Exclamation London Planetree	2.5-3" cal.	B&B	Limb to 7' ht.
QP	3	Quercus palustris	Pin Oak	2.5-3" cal.	B&B	Limb to 7' ht.
ZS	2	Zelkova serrata 'Green Vase'	Green Vase Zelkova	2.5-3" cal.	B&B	Limb to 7' ht.
ORNAMENTAL TREES						
AL	2	Amelanchier laevis 'Snowcloud'	Snowcloud Serviceberry	2.5-3" cal.	B&B	Single Stem
BN	4	Betula nigra 'Heritage'	Heritage River Birch	2.5-3" cal.	B&B	Single Stem
PS	1	Prunus serrulata 'Kwanzan'	Kwanzan Japanese Cherry	2.5-3" cal.	B&B	
PC	3	Prunus virginiana 'Canada Red Select'	Canada Red Select Chokecherry	2.5-3" cal.	B&B	
SHRUBS						
RA	8	Rhus aromatica 'Gro-Low'	Gro-Low Fragrant Sumac	2 gal.	CONT.	30" O.C.Spacing

NOTES:

1. FOR PLANTING NOTES, REFER TO SHEET 230.
2. FOR MASTER PLANT LIST, REFER TO SHEET 256.
3. FOR LANDSCAPING DETAILS, REFER TO SHEETS 254-256.

**WATERTOWN
ROUTE 16 (MOUNT AUBURN STREET)**

STATE	FED. AID PROJ. NO.	SHEET NO.	TOTAL SHEETS
MA	-	232	391
PROJECT FILE NO. 607777			



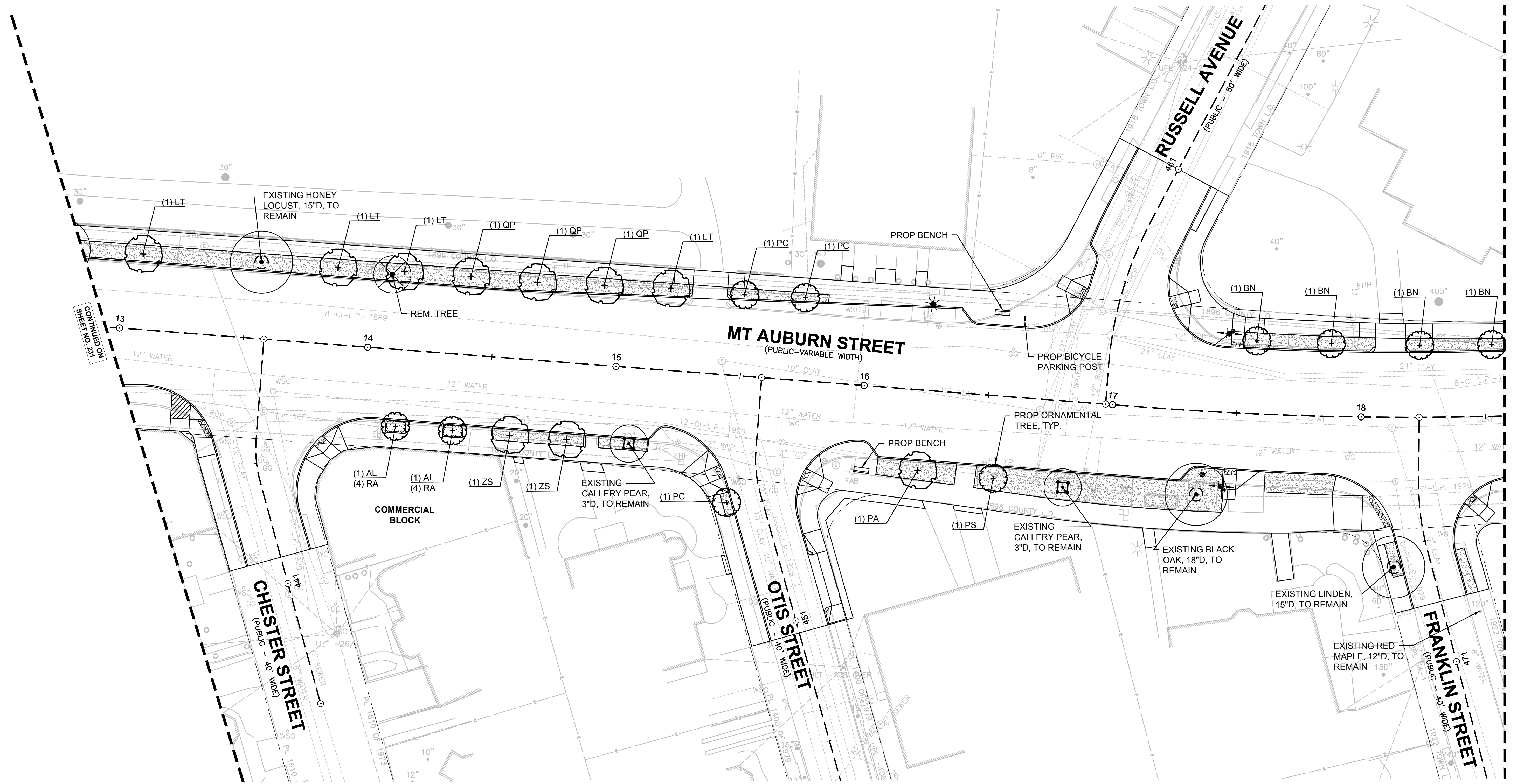
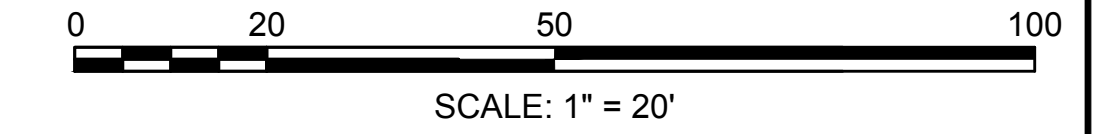







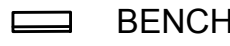

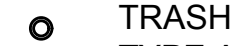
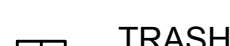
**LANDSCAPING PLAN
SHEET 3 OF 18**



CONTINUED ON SHEET NO. 231

CONTINUED ON SHEET NO. 233

LEGEND

-  BENCH
-  TABLE
-  TRASH RECEPTACLE TYPE A
-  TRASH RECEPTACLE TYPE B
-  BICYCLE PARKING POST
-  EXISTING SMALL TREE WITH TREE PROTECTION (< 4" CAL.)
-  EXISTING LARGE TREE WITH TREE PROTECTION
-  PROPOSED DECIDUOUS SHADE TREE
-  PROPOSED ORNAMENTAL TREE
-  PROPOSED EVERGREEN TREE
-  PROPOSED SHRUBS
-  PROPOSED PERENNIALS, ORNAMENTAL GRASSES, & GROUNDCOVERS
-  LAWN

SHEET 4 PLANT LIST

SYM	QTY	BOTANICAL NAME	COMMON NAME	SIZE	ROOT	COMMENTS
DECIDUOUS SHADE TREES						
PA	2	Platanus x acerifolia 'Exclamation'	Exclamation London Planetree	2.5-3" cal.	B&B	Limb to 7' ht.
QP	1	Quercus palustris	Pin Oak	2.5-3" cal.	B&B	Limb to 7' ht.
ORNAMENTAL TREES						
AL	1	Amelanchier laevis 'Snowcloud'	Snowcloud Serviceberry	2.5-3" cal.	B&B	Single Stem
BN	1	Betula nigra 'Heritage'	Heritage River Birch	2.5-3" cal.	B&B	Single Stem
MA	1	Malus 'Adirondack'	Adirondack Crabapple	2.5-3" cal.	B&B	
PS	2	Prunus serrulata 'Kwanzan'	Kwanzan Japanese Cherry	2.5-3" cal.	B&B	

NOTES:

1. FOR PLANTING NOTES, REFER TO SHEET 230.
2. FOR MASTER PLANT LIST, REFER TO SHEET 256.
3. FOR LANDSCAPING DETAILS, REFER TO SHEETS 254-256.

**WATERTOWN
ROUTE 16 (MOUNT AUBURN STREET)**

STATE	FED. AID PROJ. NO.	SHEET NO.	TOTAL SHEETS
MA	-	233	391
PROJECT FILE NO.		607777	

**LANDSCAPING PLAN
SHEET 4 OF 18**

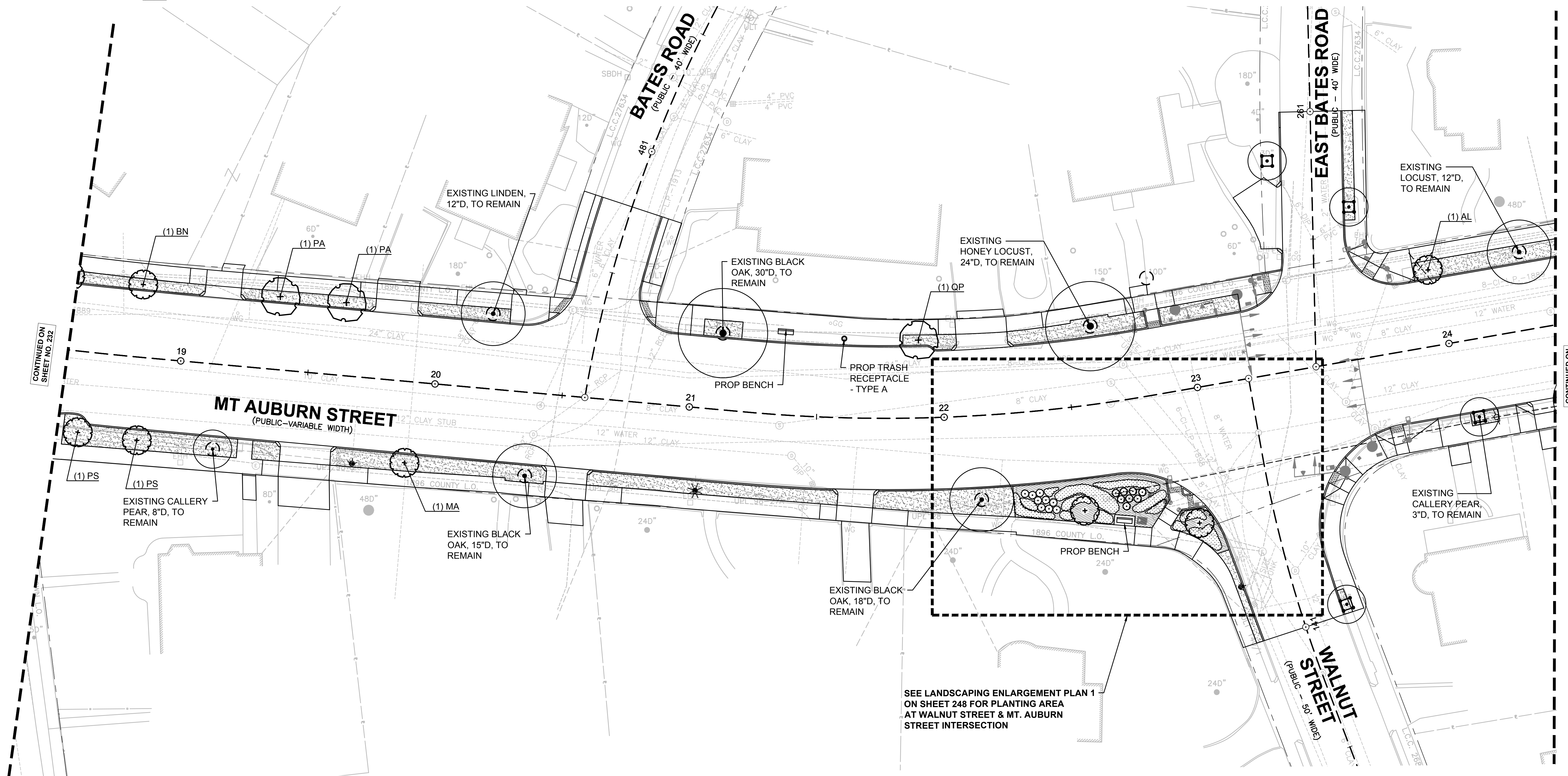
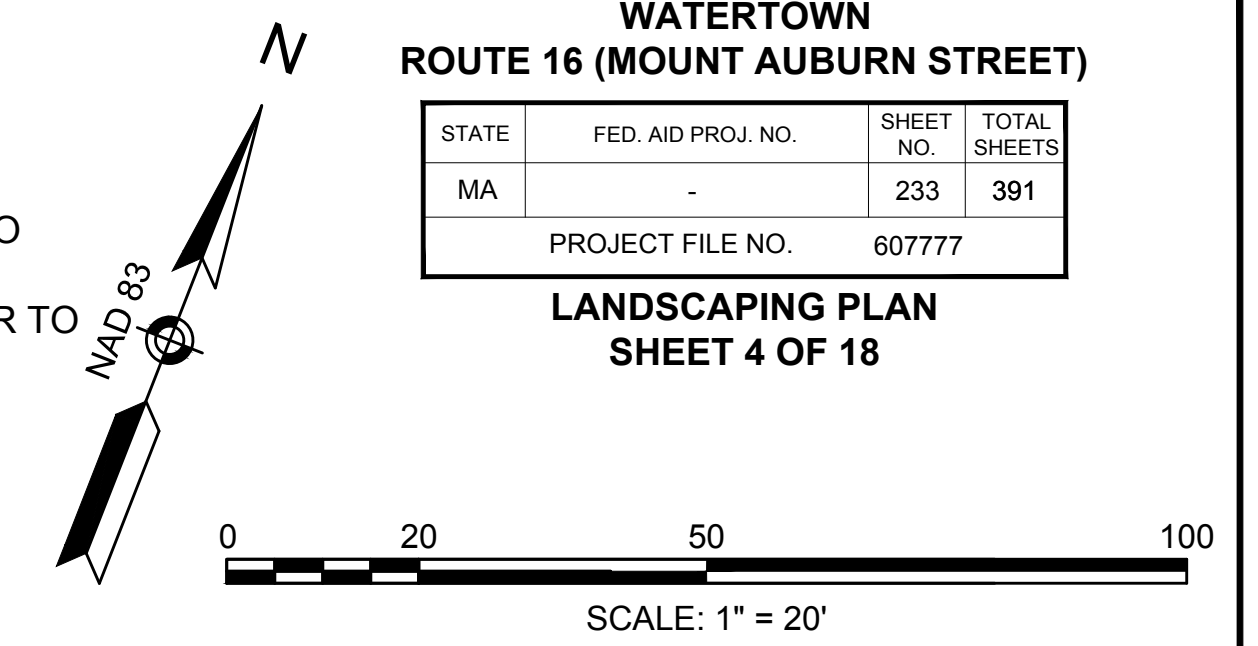









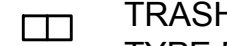

CONTINUED ON SHEET NO. 232

CONTINUED ON SHEET NO. 234

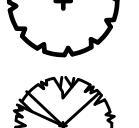
SEE LANDSCAPING ENLARGEMENT PLAN 1 ON SHEET 248 FOR PLANTING AREA AT WALNUT STREET & MT. AUBURN STREET INTERSECTION

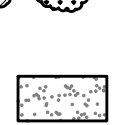
LEGEND

-  BENCH
-  TABLE
-  TRASH RECEPTACLE TYPE A
-  TRASH RECEPTACLE TYPE B
-  BICYCLE PARKING POST
-  EXISTING SMALL TREE WITH TREE PROTECTION (< 4" CAL.)
-  EXISTING LARGE TREE WITH TREE PROTECTION
-  PROPOSED DECIDUOUS SHADE TREE
-  PROPOSED ORNAMENTAL TREE
-  PROPOSED EVERGREEN TREE
-  PROPOSED SHRUBS
-  PROPOSED PERENNIALS, ORNAMENTAL GRASSES, & GROUNDCOVERS
-  LAWN

SHEET 5 PLANT LIST

SYM	QTY	BOTANICAL NAME	COMMON NAME	SIZE	ROOT	COMMENTS
DECIDUOUS SHADE TREES						
QP	1	Quercus palustris	Pin Oak	2.5-3" cal.	B&B	Limb to 7' ht.
ZS	2	Zelkova serrata 'Green Vase'	Green Vase Zelkova	2.5-3" cal.	B&B	Limb to 7' ht.
ORNAMENTAL TREES						
AL	2	Amelanchier laevis 'Snowcloud'	Snowcloud Serviceberry	2.5-3" cal.	B&B	Single Stem
CC	5	Cercis canadensis	Eastern Redbud	2.5-3" cal.	B&B	Single Stem
CA	2	Cornus 'Aurora'	Aurora Dogwood	2.5-3" cal.	B&B	
SR	2	Syringa reticulata 'Ivory Silk'	Ivory Silk Japanese Tree Lilac	2.5-3" cal.	B&B	Single Stem

NOTES:

1. FOR PLANTING NOTES, REFER TO SHEET 230.
2. FOR MASTER PLANT LIST, REFER TO SHEET 256.
3. FOR LANDSCAPING DETAILS, REFER TO SHEETS 254-256.

**WATERTOWN
ROUTE 16 (MOUNT AUBURN STREET)**

STATE	FED. AID PROJ. NO.	SHEET NO.	TOTAL SHEETS
MA	-	234	391
PROJECT FILE NO. 607777			

**LANDSCAPING PLAN
SHEET 5 OF 18**

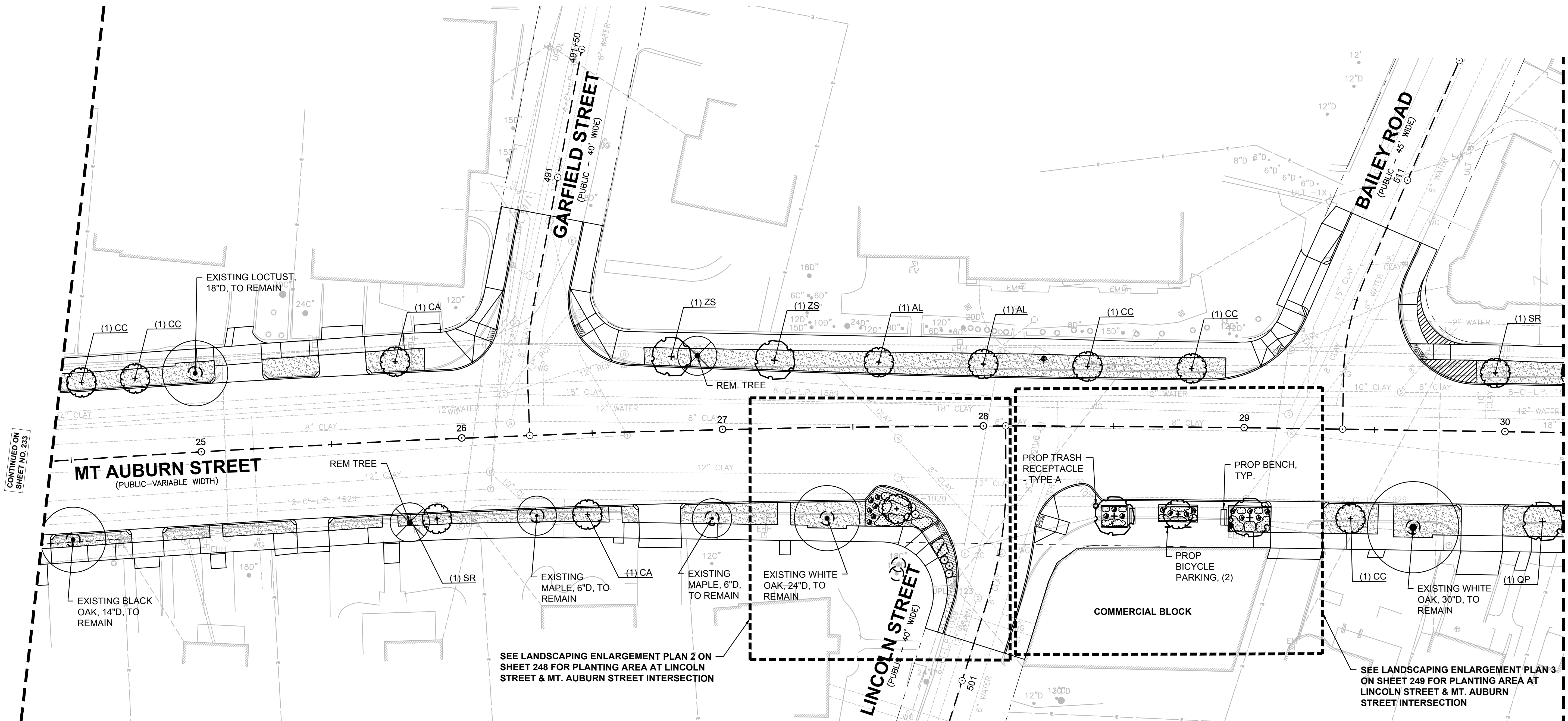
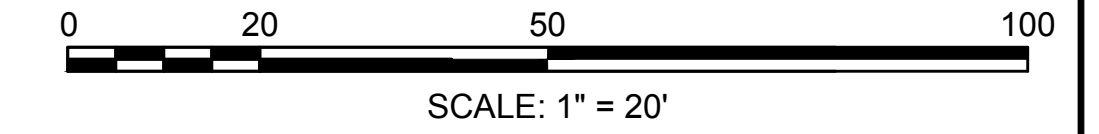
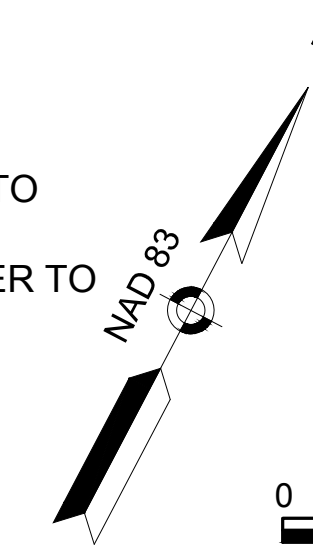











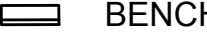

CONTINUED ON SHEET NO. 233

CONTINUED ON SHEET NO. 235

SEE LANDSCAPING ENLARGEMENT PLAN 2 ON SHEET 248 FOR PLANTING AREA AT LINCOLN STREET & MT. AUBURN STREET INTERSECTION

SEE LANDSCAPING ENLARGEMENT PLAN 3 ON SHEET 249 FOR PLANTING AREA AT LINCOLN STREET & MT. AUBURN STREET INTERSECTION

LEGEND

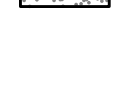
-  BENCH
-  TABLE
-  TRASH RECEPTACLE TYPE A
-  TRASH RECEPTACLE TYPE B
-  BICYCLE PARKING POST
-  EXISTING SMALL TREE WITH TREE PROTECTION (< 4" CAL.)
-  EXISTING LARGE TREE WITH TREE PROTECTION
-  PROPOSED DECIDUOUS SHADE TREE
-  PROPOSED ORNAMENTAL TREE
-  PROPOSED EVERGREEN TREE
-  PROPOSED SHRUBS
-  PROPOSED PERENNIALS, ORNAMENTAL GRASSES, & GROUNDCOVERS
-  LAWN

SHEET 6 PLANT LIST

SYM	QTY	BOTANICAL NAME	COMMON NAME	SIZE	ROOT	COMMENTS
DECIDUOUS SHADE TREES						
LT	2	Liriodendron tulipifera 'Emerald City'	Emerald City Tulip Tree	2.5-3" cal.	B&B	Limb to 7' ht.
QA	2	Quercus alba	White Oak	2.5-3" cal.	B&B	Limb to 7' ht.
ORNAMENTAL TREES						
AL	3	Amelanchier laevis 'Snowcloud'	Snowcloud Serviceberry	2.5-3" cal.	B&B	Single Stem
CC	2	Cercis canadensis	Eastern Redbud	2.5-3" cal.	B&B	Single Stem
MS	3	Malus 'Spring Snow'	Spring Snow Crabapple	2.5-3" cal.	B&B	Fruitless variety
PS	1	Prunus serrulata 'Kwanzan'	Kwanzan Japanese Cherry	2.5-3" cal.	B&B	
SR	3	Syringa reticulata 'Ivory Silk'	Ivory Silk Japanese Tree Lilac	2.5-3" cal.	B&B	Single Stem
SHRUBS						
CS	9	Cornus sericea 'Arctic Fire'	Arctic Fire Red Twig Dogwood	18-24" ht.	CONT.	
IG	10	Ilex glabra 'Shamrock'	Shamrock Inkberry	24-30" ht.	CONT.	
PERENNIALS, ORNAMENTAL GRASSES & GROUNDCOVERS						
HH	7	Hemerocallis 'Happy Returns'	Happy Returns Daylily	1 gal.	CONT.	18" O.C. Spacing
HJ	7	Hemerocallis 'Joan Senior'	Joan Senior Daylily	1 gal.	CONT.	18" O.C. Spacing

NOTES:

1. FOR PLANTING NOTES, REFER TO SHEET 230.
2. FOR MASTER PLANT LIST, REFER TO SHEET 256.
3. FOR LANDSCAPING DETAILS, REFER TO SHEETS 254-256.

**WATERTOWN
ROUTE 16 (MOUNT AUBURN STREET)**

STATE	FED. AID PROJ. NO.	SHEET NO.	TOTAL SHEETS
MA	-	235	391

PROJECT FILE NO. 607777

**LANDSCAPING PLAN
SHEET 6 OF 18**

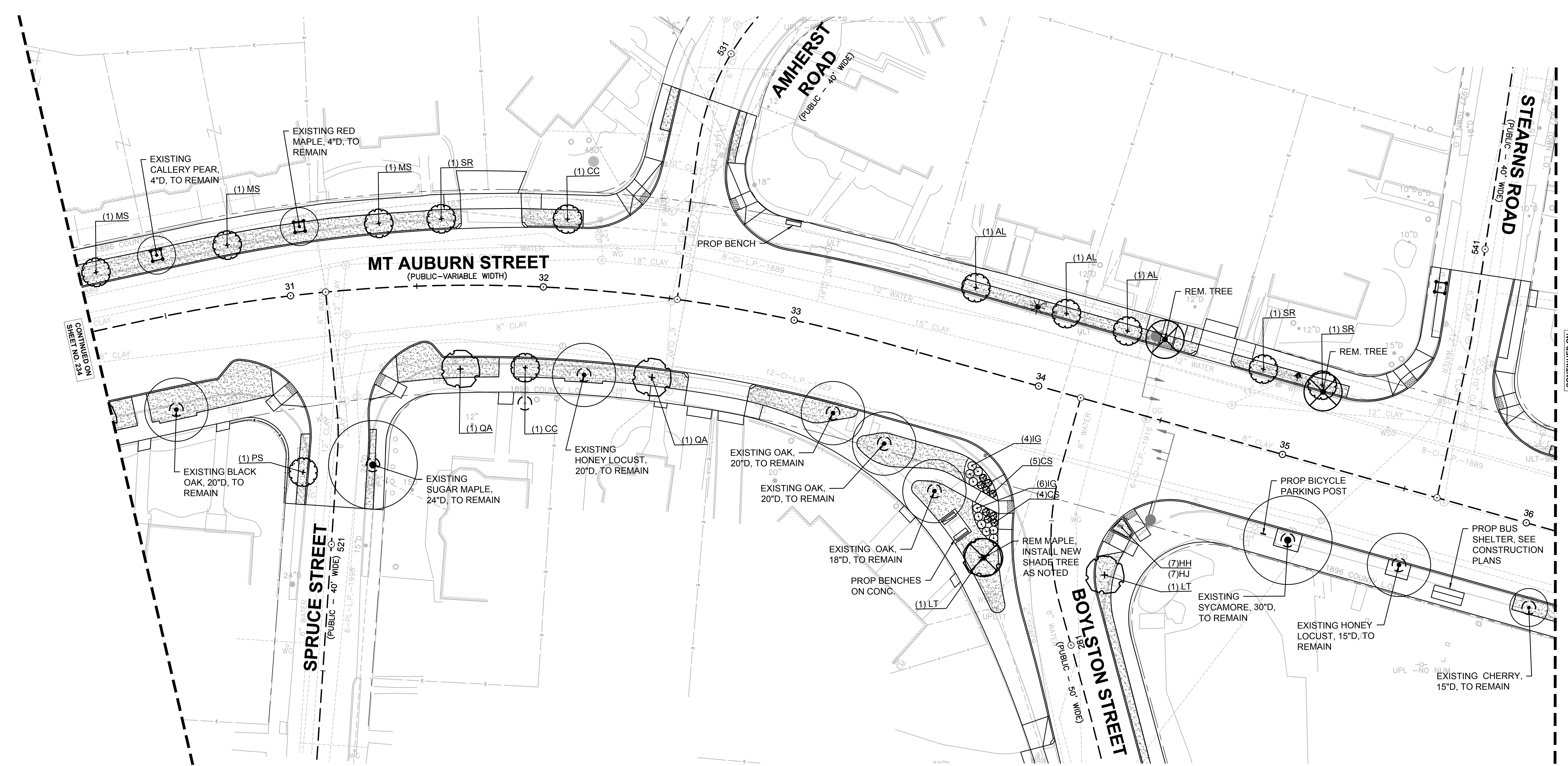
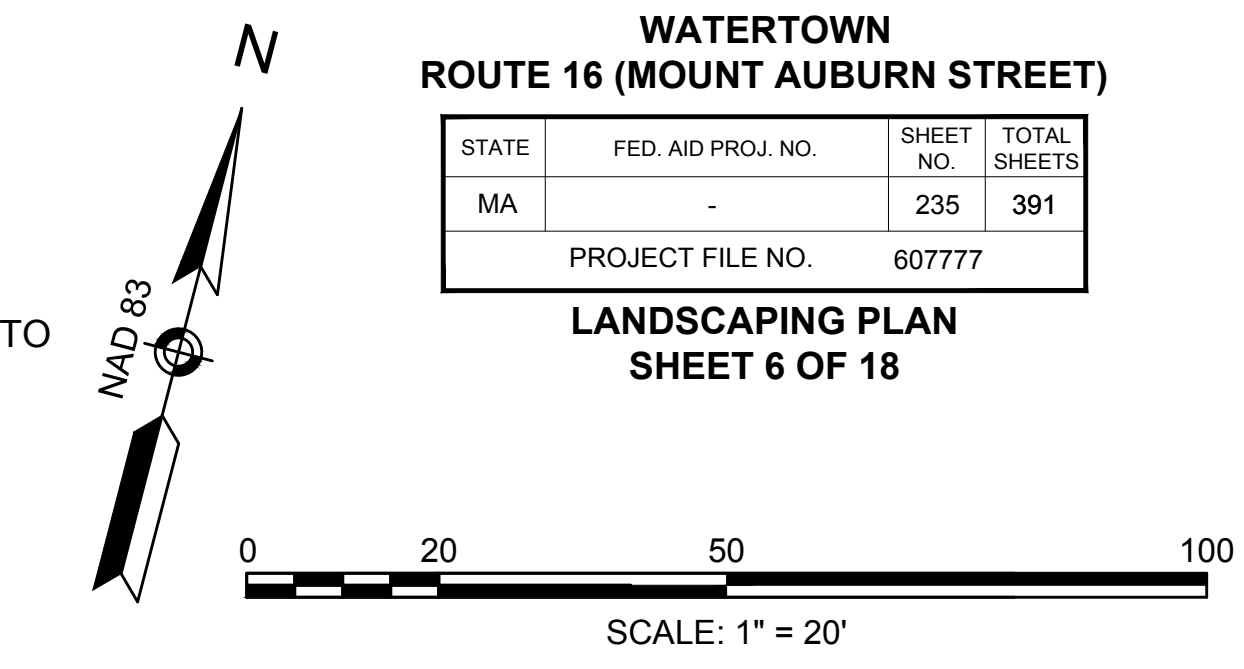

CONTINUED ON SHEET NO. 234

CONTINUED ON SHEET NO. 236

LEGEND

- BENCH
- TABLE
- TRASH RECEPTACLE TYPE A
- TRASH RECEPTACLE TYPE B
- BICYCLE PARKING POST
- EXISTING SMALL TREE WITH TREE PROTECTION (< 4" CAL.)
- EXISTING LARGE TREE WITH TREE PROTECTION
- PROPOSED DECIDUOUS SHADE TREE
- PROPOSED ORNAMENTAL TREE
- PROPOSED EVERGREEN TREE
- PROPOSED SHRUBS
- PROPOSED PERENNIALS, ORNAMENTAL GRASSES, & GROUNDCOVERS
- LAWN

SHEET 7 PLANT LIST

SYM	QTY	BOTANICAL NAME	COMMON NAME	SIZE	ROOT	COMMENTS
DECIDUOUS SHADE TREES						
GB	1	Ginkgo biloba 'Princeton Sentry'	Princeton Sentry Maidenhair Tree	2.5-3" cal.	B&B	Limb to 7' ht.
LT	1	Liriodendron tulipifera 'Emerald City'	Emerald City Tulip Tree	2.5-3" cal.	B&B	Limb to 7' ht.
ORNAMENTAL TREES						
BN	2	Betula nigra 'Heritage'	Heritage River Birch	2.5-3" cal.	B&B	Single Stem
CC	1	Cercis canadensis	Eastern Redbud	2.5-3" cal.	B&B	Single Stem
MA	1	Malus 'Adirondack'	Adirondack Crabapple	2.5-3" cal.	B&B	
MS	2	Malus 'Spring Snow'	Spring Snow Crabapple	2.5-3" cal.	B&B	Fruitless variety
PS	1	Prunus serrulata 'Kwanzan'	Kwanzan Japanese Cherry	2.5-3" cal.	B&B	

NOTES:

- FOR PLANTING NOTES, REFER TO SHEET 230.
- FOR MASTER PLANT LIST, REFER TO SHEET 256.
- FOR LANDSCAPING DETAILS, REFER TO SHEETS 254-256.

WATERTOWN
ROUTE 16 (MOUNT AUBURN STREET)

STATE	FED. AID PROJ. NO.	SHEET NO.	TOTAL SHEETS
MA	-	236	391
PROJECT FILE NO.		607777	

LANDSCAPING PLAN
SHEET 7 OF 18

NAD 83



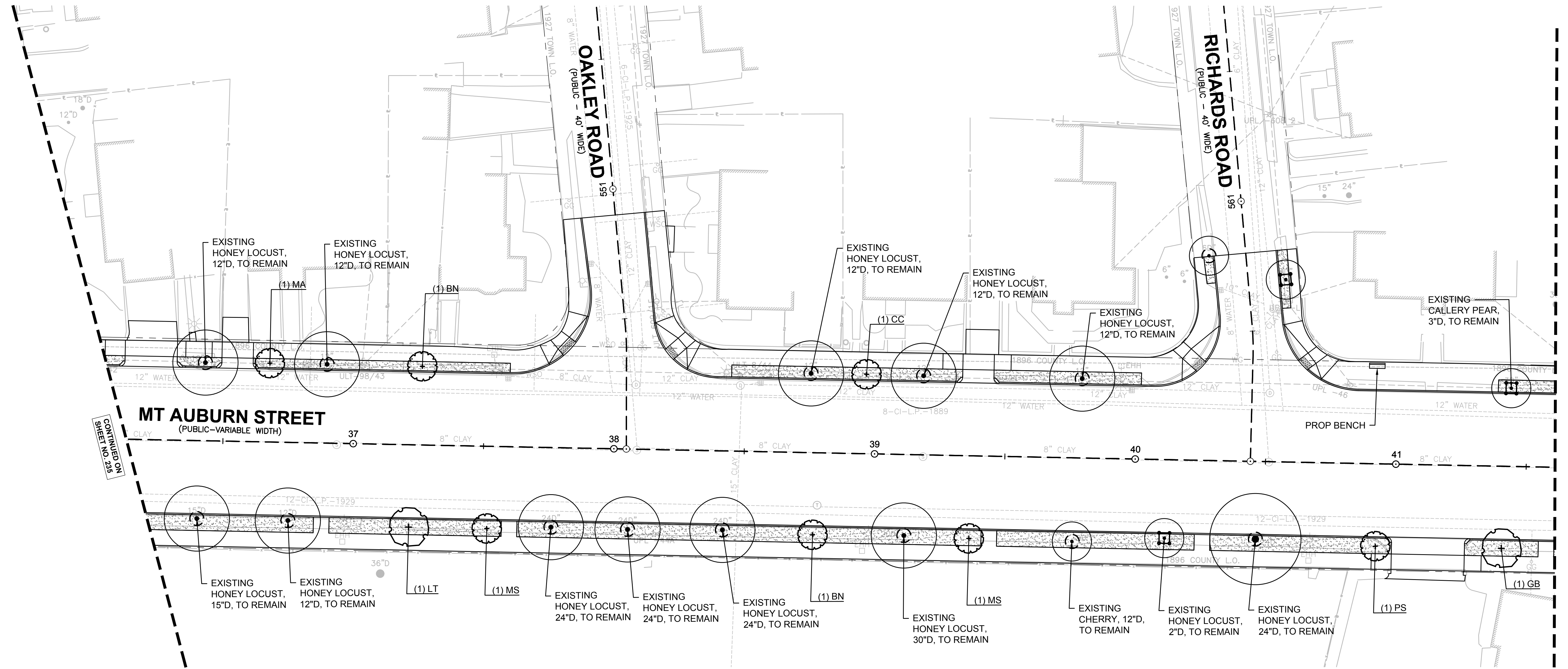







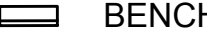

SCALE: 1" = 20'

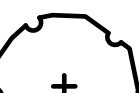

CONTINUED ON SHEET NO. 235

CONTINUED ON SHEET NO. 237

LEGEND

-  BENCH
-  TABLE
-  TRASH RECEPTACLE TYPE A
-  TRASH RECEPTACLE TYPE B
-  BICYCLE PARKING POST
-  EXISTING SMALL TREE WITH TREE PROTECTION (< 4" CAL.)
-  EXISTING LARGE TREE WITH TREE PROTECTION
-  PROPOSED DECIDUOUS SHADE TREE
-  PROPOSED ORNAMENTAL TREE
-  PROPOSED EVERGREEN TREE
-  PROPOSED SHRUBS
-  PROPOSED PERENNIALS, ORNAMENTAL GRASSES, & GROUNDCOVERS
-  LAWN

SHEET 8 PLANT LIST

SYM	QTY	BOTANICAL NAME	COMMON NAME	SIZE	ROOT	COMMENTS
DECIDUOUS SHADE TREES						
GB	3	Ginkgo biloba 'Princeton Sentry'	Princeton Sentry Maidenhair Tree	2.5-3" cal.	B&B	Limb to 7' ht.
PR	2	Parrotia 'Ruby Vase'	Ruby Vase Parrotia	2.5-3" cal.	B&B	Limb to 7' ht.
ORNAMENTAL TREES						
AL	5	Amelanchier laevis 'Snowcloud'	Snowcloud Serviceberry	2.5-3" cal.	B&B	Single Stem
CC	1	Cercis canadensis	Eastern Redbud	2.5-3" cal.	B&B	Single Stem
CA	2	Cornus 'Aurora'	Aurora Dogwood	2.5-3" cal.	B&B	
MS	1	Malus 'Spring Snow'	Spring Snow Crabapple	2.5-3" cal.	B&B	Fruitless variety
PS	4	Prunus serrulata 'Kwanzan'	Kwanzan Japanese Cherry	2.5-3" cal.	B&B	
PC	1	Prunus virginiana 'Canada Red Select'	Canada Red Select Chokecherry	2.5-3" cal.	B&B	
SR	7	Syringa reticulata 'Ivory Silk'	Ivory Silk Japanese Tree Lilac	2.5-3" cal.	B&B	Single Stem
GROUNDCOVERS						
VM	90	Vinca minor 'Bowles'	Bowles Periwinkle	4" pot	CONT.	12" O.C. Spacing

NOTES:

1. FOR PLANTING NOTES, REFER TO SHEET 230.
2. FOR MASTER PLANT LIST, REFER TO SHEET 256.
3. FOR LANDSCAPING DETAILS, REFER TO SHEETS 254-256.

**WATERTOWN
ROUTE 16 (MOUNT AUBURN STREET)**

STATE	FED. AID PROJ. NO.	SHEET NO.	TOTAL SHEETS
MA	-	237	391
PROJECT FILE NO.		607777	



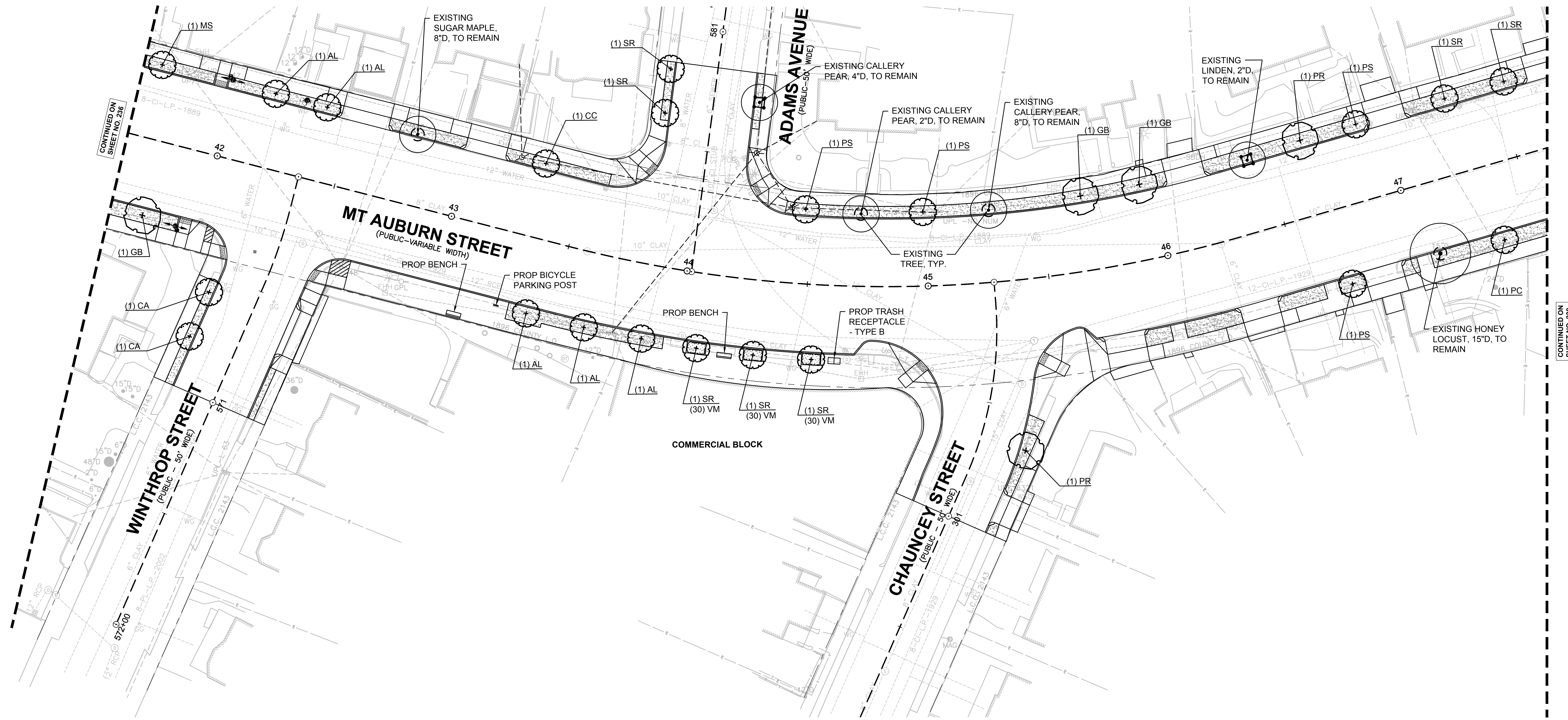
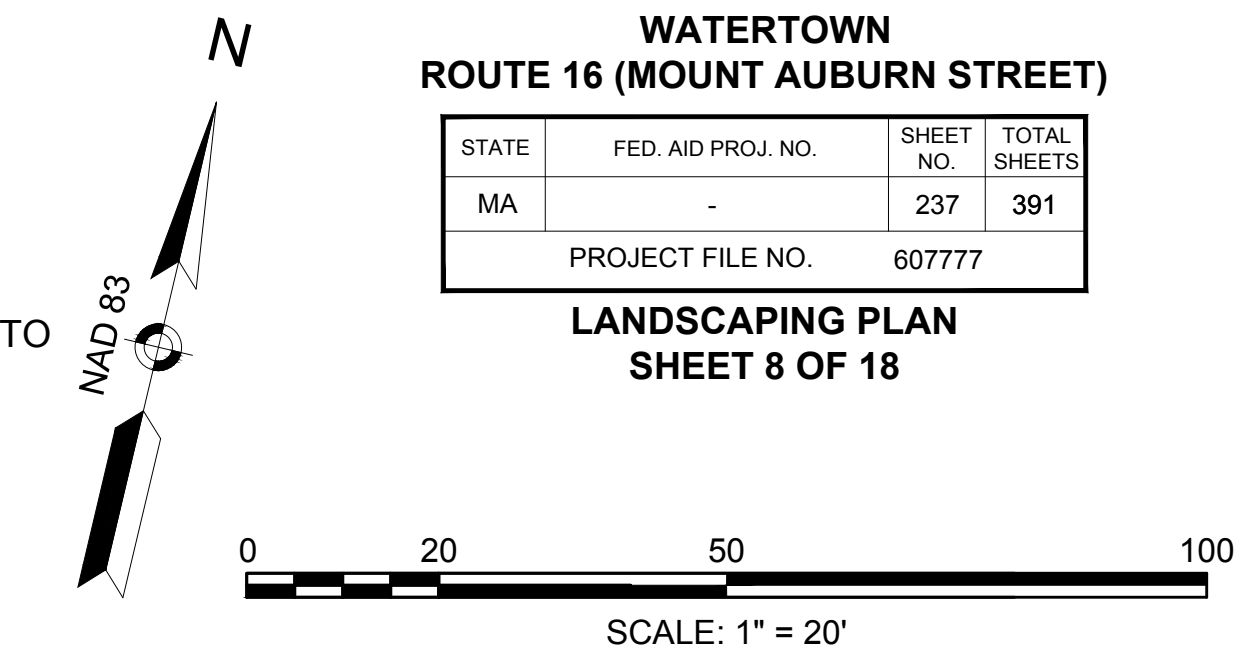





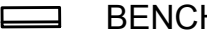

**LANDSCAPING PLAN
SHEET 8 OF 18**

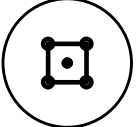

CONTINUED ON SHEET NO. 236

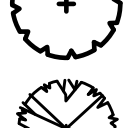
CONTINUED ON SHEET NO. 238

LEGEND

-  BENCH
-  TABLE
-  TRASH RECEPTACLE TYPE A
-  TRASH RECEPTACLE TYPE B
-  BICYCLE PARKING POST
-  EXISTING SMALL TREE WITH TREE PROTECTION (< 4" CAL.)
-  EXISTING LARGE TREE WITH TREE PROTECTION
-  PROPOSED DECIDUOUS SHADE TREE
-  PROPOSED ORNAMENTAL TREE
-  PROPOSED EVERGREEN TREE
-  PROPOSED SHRUBS
-  PROPOSED PERENNIALS, ORNAMENTAL GRASSES, & GROUNDCOVERS
-  LAWN

SHEET 9 PLANT LIST

SYM	QTY	BOTANICAL NAME	COMMON NAME	SIZE	ROOT	COMMENTS
DECIDUOUS SHADE TREES						
LS	2	Liquidambar styraciflua 'Rotundiloba'	Rotundiloba Sweetgum (fruitless)	2.5-3" cal.	B&B	Limb to 7' ht.
NS	2	Nyssa sylvatica 'Wildfire'	Wildfire Sour Gum	2.5-3" cal.	B&B	Limb to 7' ht.
QP	1	Quercus palustris	Pin Oak	2.5-3" cal.	B&B	Limb to 7' ht.
ORNAMENTAL TREES						
CC	2	Cercis canadensis	Eastern Redbud	2.5-3" cal.	B&B	Single Stem
MA	3	Malus 'Adirondack'	Adirondack Crabapple	2.5-3" cal.	B&B	
PC	2	Prunus virginiana 'Canada Red Select'	Canada Red Select Chokecherry	2.5-3" cal.	B&B	

NOTES:

1. FOR PLANTING NOTES, REFER TO SHEET 230.
2. FOR MASTER PLANT LIST, REFER TO SHEET 256.
3. FOR LANDSCAPING DETAILS, REFER TO SHEETS 254-256.

WATERTOWN
ROUTE 16 (MOUNT AUBURN STREET)

STATE	FED. AID PROJ. NO.	SHEET NO.	TOTAL SHEETS
MA	-	238	391
PROJECT FILE NO.		607777	

LANDSCAPING PLAN
SHEET 9 OF 18

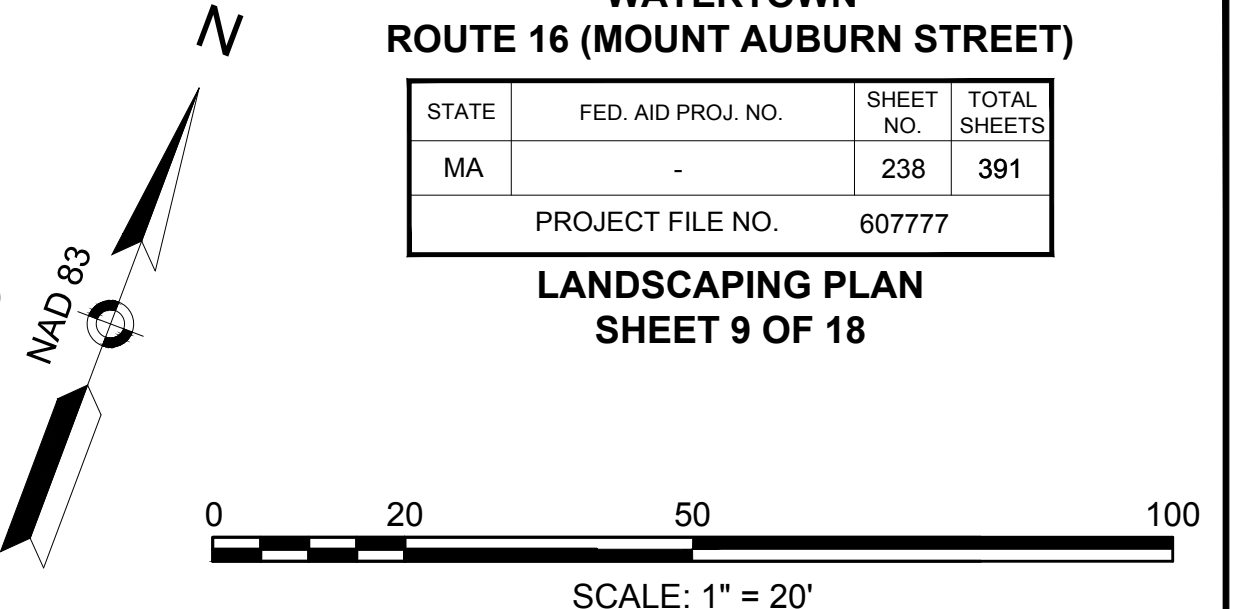



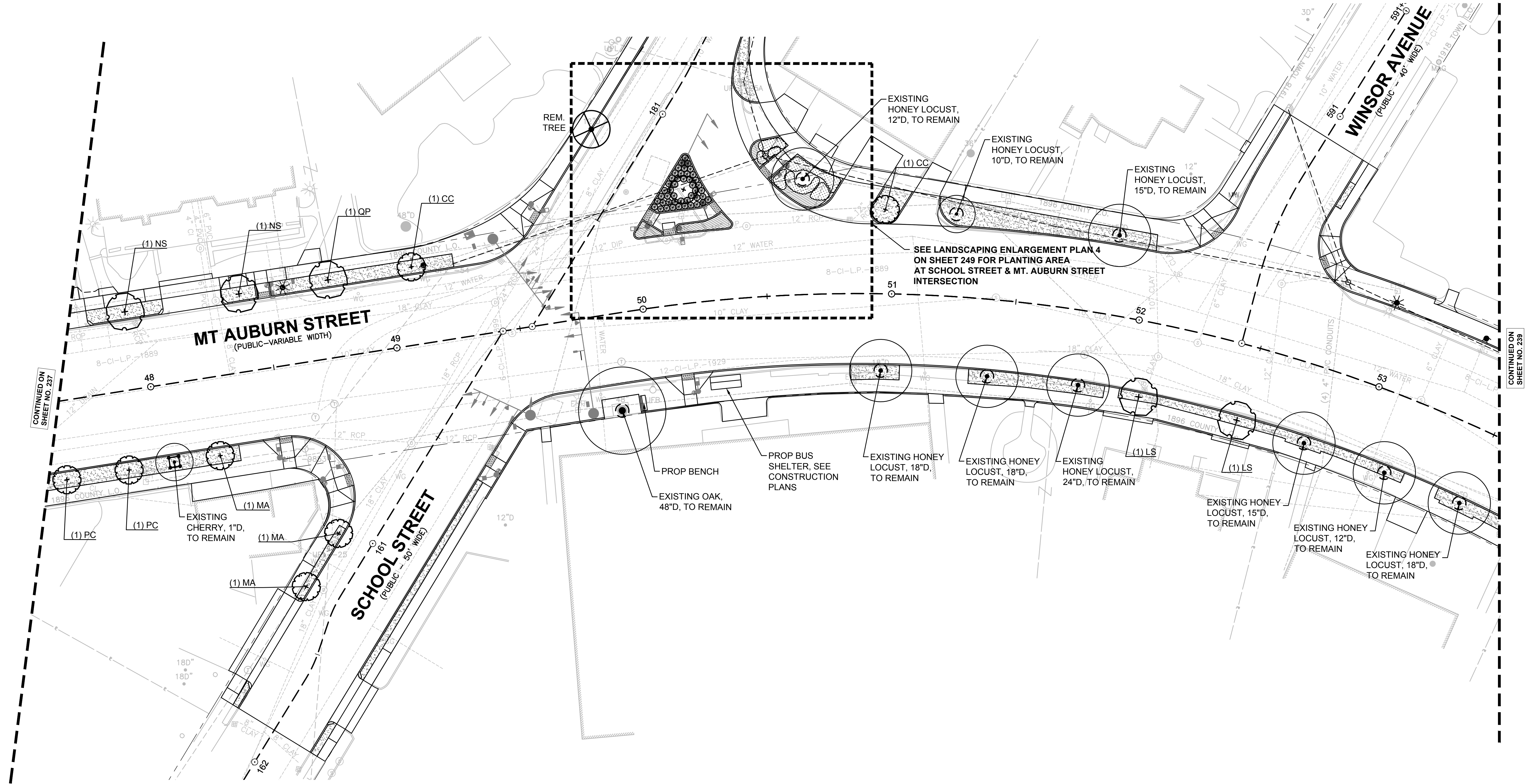







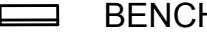

SCALE: 1" = 20'



CONTINUED ON SHEET NO. 237

CONTINUED ON SHEET NO. 239

LEGEND

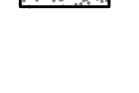
-  BENCH
-  TABLE
-  TRASH RECEPTACLE TYPE A
-  TRASH RECEPTACLE TYPE B
-  BICYCLE PARKING POST
-  EXISTING SMALL TREE WITH TREE PROTECTION (< 4" CAL.)
-  EXISTING LARGE TREE WITH TREE PROTECTION
-  PROPOSED DECIDUOUS SHADE TREE
-  PROPOSED ORNAMENTAL TREE
-  PROPOSED EVERGREEN TREE
-  PROPOSED SHRUBS
-  PROPOSED PERENNIALS, ORNAMENTAL GRASSES, & GROUNDCOVERS
-  LAWN

SHEET 10 PLANT LIST

SYM	QTY	BOTANICAL NAME	COMMON NAME	SIZE	ROOT	COMMENTS
DECIDUOUS SHADE TREES						
LS	1	Liquidambar styraciflua 'Rotundiloba'	Rotundiloba Sweetgum (fruitless)	2.5-3" cal.	B&B	Limb to 7' ht.
ZS	2	Zelkova serrata 'Green Vase'	Green Vase Japanese Zelkova	2.5-3" cal.	B&B	Limb to 7' ht.
ORNAMENTAL TREES						
AL	4	Amelanchier laevis 'Snowcloud'	Snowcloud Serviceberry	2.5-3" cal.	B&B	Single Stem
CA	2	Cornus 'Aurora'	Aurora Dogwood	2.5-3" cal.	B&B	
PS	2	Prunus serrulata 'Kwanzan'	Kwanzan Japanese Cherry	2.5-3" cal.	B&B	
SR	1	Syringa reticulata 'Ivory Silk'	Ivory Silk Japanese Tree Lilac	2.5-3" cal.	B&B	Single Stem
PERENNIALS, ORNAMENTAL GRASSES & GROUNDCOVERS						
CR	190	Carex amphiloeba	Creek Sedge		PLUG	12" O.C. Spacing

NOTES:

1. FOR PLANTING NOTES, REFER TO SHEET 230.
2. FOR MASTER PLANT LIST, REFER TO SHEET 256.
3. FOR LANDSCAPING DETAILS, REFER TO SHEETS 254-256.

**WATERTOWN
ROUTE 16 (MOUNT AUBURN STREET)**

STATE	FED. AID PROJ. NO.	SHEET NO.	TOTAL SHEETS
MA	-	239	391

PROJECT FILE NO. 607777



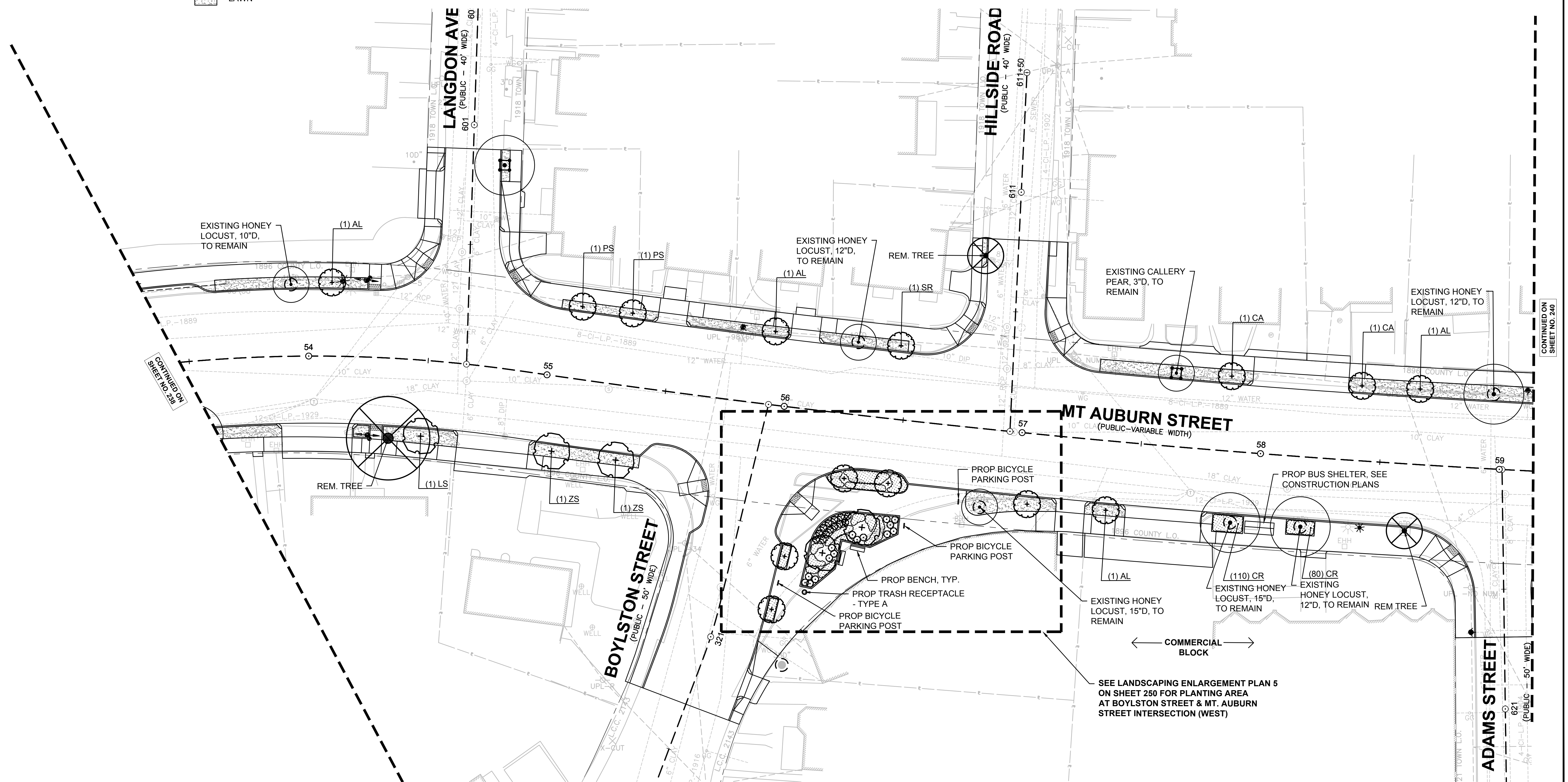
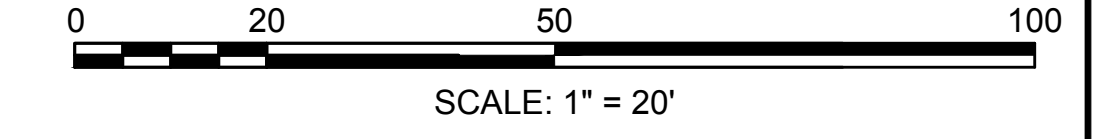
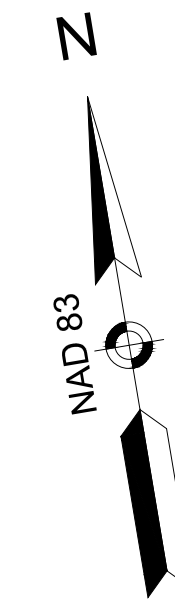







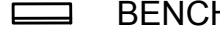

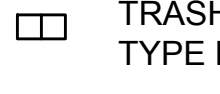
**LANDSCAPING PLAN
SHEET 10 OF 18**



CONTINUED ON SHEET NO. 238

CONTINUED ON SHEET NO. 240

LEGEND

-  BENCH
-  TABLE
-  TRASH RECEPTACLE TYPE A
-  TRASH RECEPTACLE TYPE B
-  BICYCLE PARKING POST
-  EXISTING SMALL TREE WITH TREE PROTECTION (< 4" CAL.)
-  EXISTING LARGE TREE WITH TREE PROTECTION
-  PROPOSED DECIDUOUS SHADE TREE
-  PROPOSED ORNAMENTAL TREE
-  PROPOSED EVERGREEN TREE
-  PROPOSED SHRUBS
-  PROPOSED PERENNIALS, ORNAMENTAL GRASSES, & GROUNDCOVERS
-  LAWN

SHEET 11 PLANT LIST

SYM	QTY	BOTANICAL NAME	COMMON NAME	SIZE	ROOT	COMMENTS
DECIDUOUS SHADE TREES						
NS	1	<i>Nyssa sylvatica</i> 'Wildfire'	Wildfire Sour Gum	2.5-3" cal.	B&B	Limb to 7' ht.
PR	9	<i>Parrotia</i> 'Ruby Vase'	Ruby Vase Parrotia	2.5-3" cal.	B&B	Limb to 7' ht.
ZS	2	<i>Zelkova serrata</i> 'Green Vase'	Green Vase Japanese Zelkova	2.5-3" cal.	B&B	Limb to 7' ht.
ORNAMENTAL TREES						
AL	1	<i>Amelanchier laevis</i> 'Snowcloud'	Snowcloud Serviceberry	2.5-3" cal.	B&B	Single Stem
MS	3	<i>Malus</i> 'Spring Snow'	Spring Snow Crabapple	2.5-3" cal.	B&B	
PS	2	<i>Prunus serrulata</i> 'Kwanzan'	Kwanzan Japanese Cherry	2.5-3" cal.	B&B	
PC	1	<i>Prunus virginiana</i> 'Canada Red Select'	Canada Red Select Chokecherry	2.5-3" cal.	B&B	
SHRUBS						
RA	16	<i>Rhus aromatica</i> 'Gro-Low'	Gro-Low Fragrant Sumac	2 gal.	CONT.	30" O.C. Spacing
PERENNIALS, ORNAMENTAL GRASSES & GROUNDCOVERS						
CR	140	<i>Carex amphilo</i>	Creek Sedge		PLUG	12" O.C. Spacing

NOTES:

1. FOR PLANTING NOTES, REFER TO SHEET 230.
2. FOR MASTER PLANT LIST, REFER TO SHEET 256.
3. FOR LANDSCAPING DETAILS, REFER TO SHEETS 254-256.

WATERTOWN
ROUTE 16 (MOUNT AUBURN STREET)







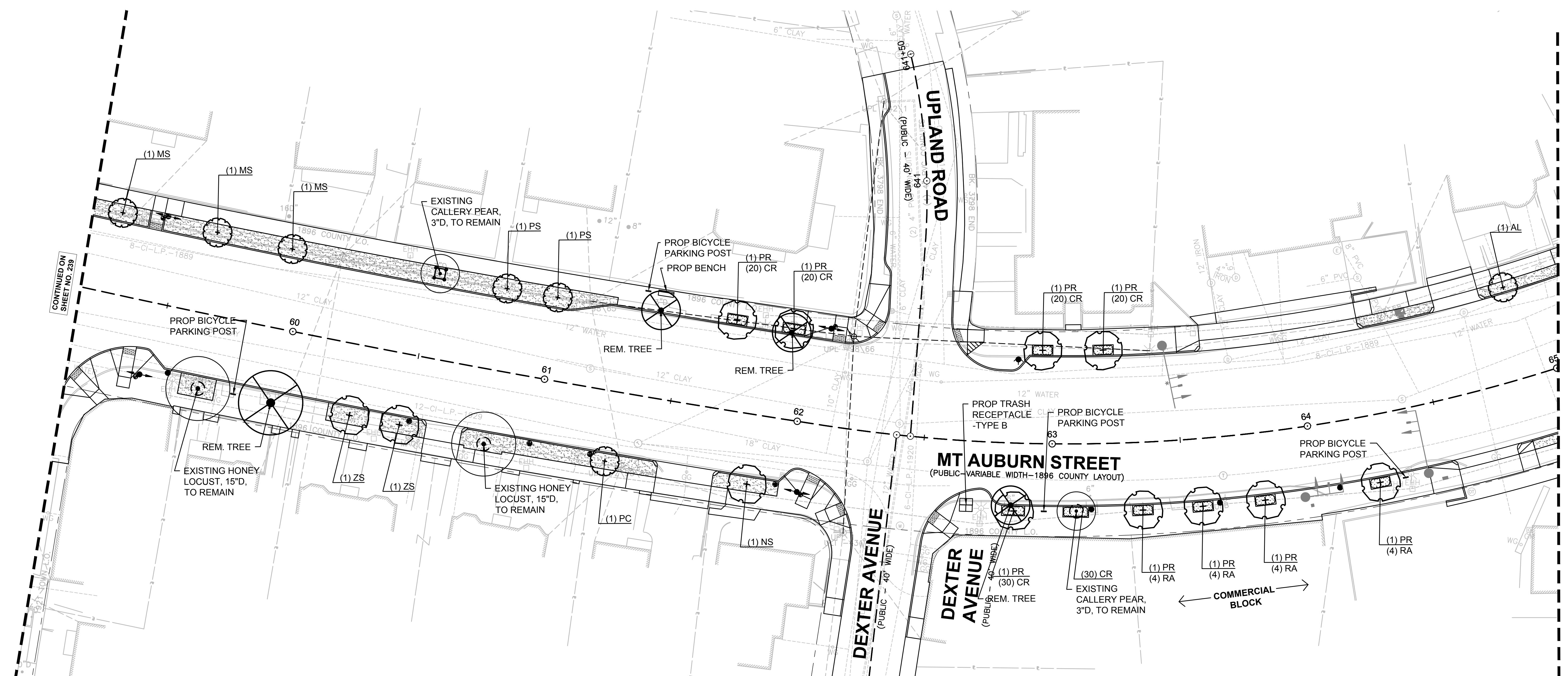

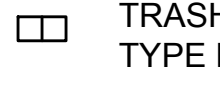

STATE	FED. AID PROJ. NO.	SHEET NO.	TOTAL SHEETS
MA	-	240	391
PROJECT FILE NO.		607777	

LANDSCAPING PLAN
SHEET 11 OF 18

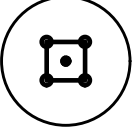
SCALE: 1" = 20'

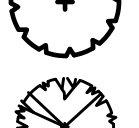

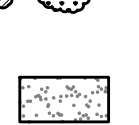
LEGEND

-  BENCH
-  TABLE
-  TRASH RECEPTACLE TYPE A
-  TRASH RECEPTACLE TYPE B
-  BICYCLE PARKING POST
-  EXISTING SMALL TREE WITH TREE PROTECTION (< 4" CAL.)
-  EXISTING LARGE TREE WITH TREE PROTECTION
-  PROPOSED DECIDUOUS SHADE TREE
-  PROPOSED ORNAMENTAL TREE
-  PROPOSED EVERGREEN TREE
-  PROPOSED SHRUBS
-  PROPOSED PERENNIALS, ORNAMENTAL GRASSES, & GROUNDCOVERS
-  LAWN

SHEET 12 PLANT LIST

SYM	QTY	BOTANICAL NAME	COMMON NAME	SIZE	ROOT	COMMENTS
DECIDUOUS SHADE TREES						
GT	1	Gleditsia triacanthos v. inermis 'Skyline'	Skyline Honeylocust	2.5-3" cal.	B&B	Limb to 7' ht.
PA	1	Platanus x acerifolia 'Exclamation'	Exclamation London Planetree	2.5-3" cal.	B&B	Limb to 7' ht.
ORNAMENTAL TREES						
AL	2	Amelanchier laevis 'Snowcloud'	Snowcloud Serviceberry	2.5-3" cal.	B&B	Single Stem
SR	3	Syringa reticulata 'Ivory Silk'	Ivory Silk Japanese Tree Lilac	2.5-3" cal.	B&B	Single Stem
SHRUBS						
RA	12	Rhus aromatica 'Gro-Low'	Gro-Low Fragrant Sumac	2 gal.	CONT.	30" O.C. Spacing
PERENNIALS, ORNAMENTAL GRASSES & GROUNDCOVERS						
CR	100	Carex amphiploba	Creek Sedge		PLUG	12" O.C. Spacing
HH	25	Hemerocallis 'Happy Returns'	Happy Returns Daylily	1 gal.	CONT.	18" O.C. Spacing
HJ	25	Hemerocallis 'Joan Senior'	Joan Senior Daylily	1 gal.	CONT.	18" O.C. Spacing
VM	255	Vinca minor 'Bowles'	Bowles Periwinkle	4" pot	CONT.	12" O.C. Spacing

NOTES:

- FOR PLANTING NOTES, REFER TO SHEET 230.
- FOR MASTER PLANT LIST, REFER TO SHEET 256.
- FOR LANDSCAPING DETAILS, REFER TO SHEETS 254-256.

**WATERTOWN
ROUTE 16 (MOUNT AUBURN STREET)**

STATE	FED. AID PROJ. NO.	SHEET NO.	TOTAL SHEETS
MA	-	241	391
PROJECT FILE NO. 607777			



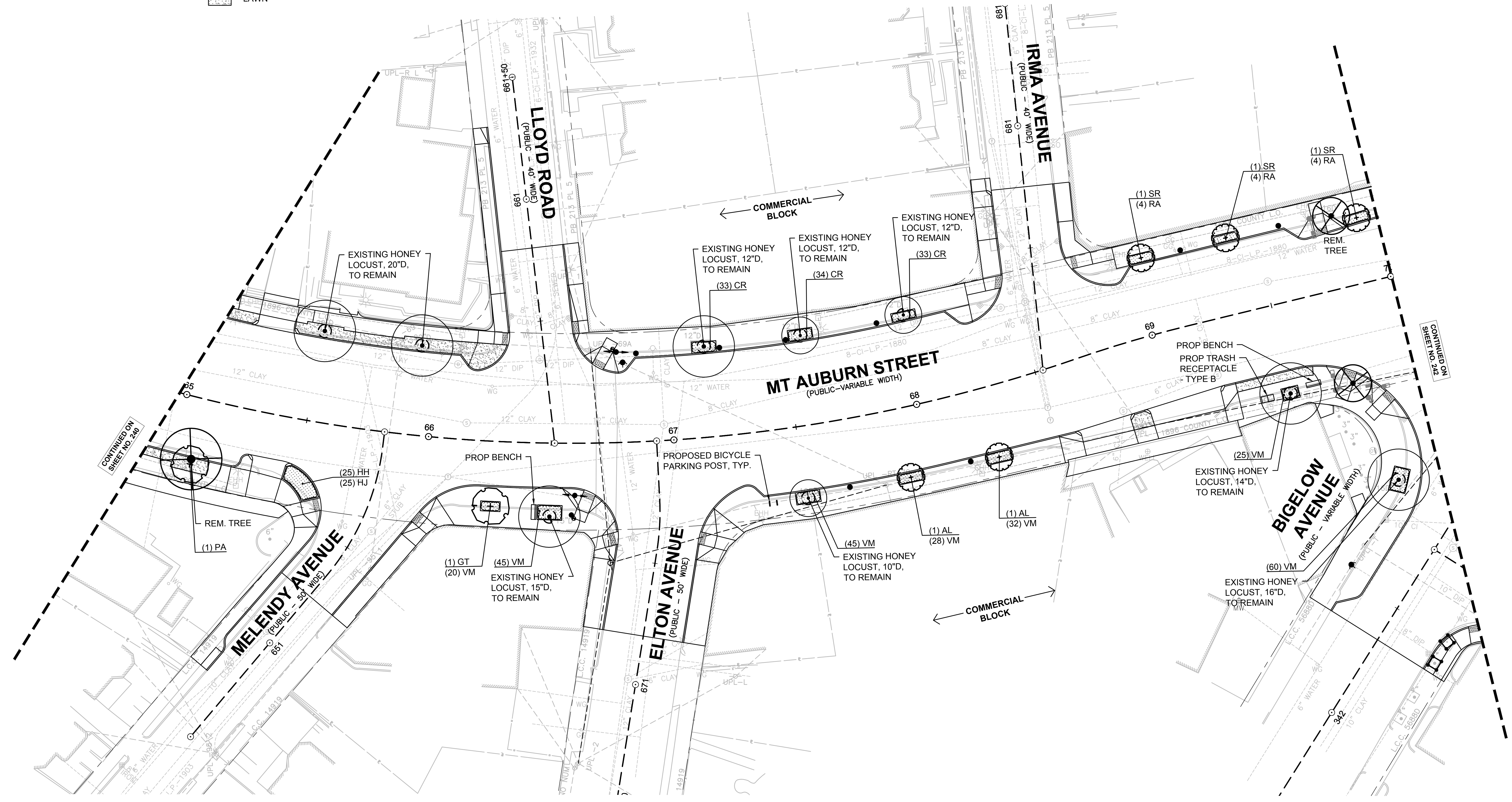
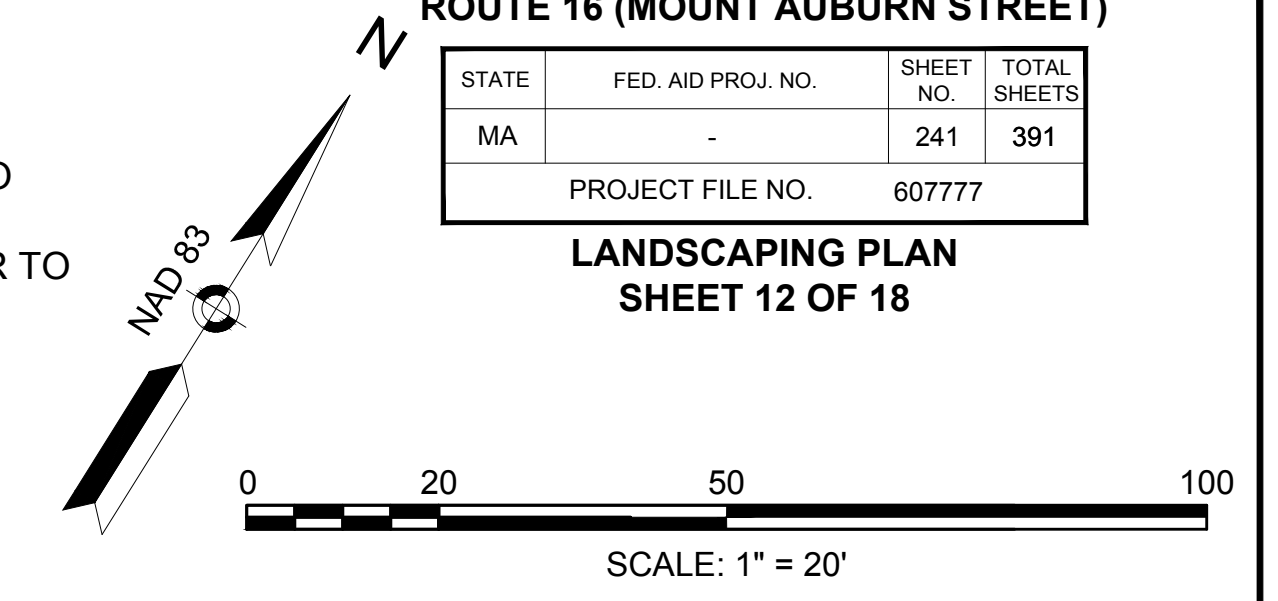







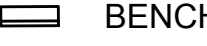

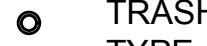
**LANDSCAPING PLAN
SHEET 12 OF 18**



CONTINUED ON SHEET NO. 240

CONTINUED ON SHEET NO. 242

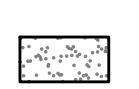
LEGEND

-  BENCH
-  TABLE
-  TRASH RECEPTACLE TYPE A
-  TRASH RECEPTACLE TYPE B
-  BICYCLE PARKING POST
-  EXISTING SMALL TREE WITH TREE PROTECTION (< 4" CAL.)
-  EXISTING LARGE TREE WITH TREE PROTECTION
-  PROPOSED DECIDUOUS SHADE TREE
-  PROPOSED ORNAMENTAL TREE
-  PROPOSED EVERGREEN TREE
-  PROPOSED SHRUBS
-  PROPOSED PERENNIALS, ORNAMENTAL GRASSES, & GROUNDCOVERS
-  LAWN

SHEET 13 PLANT LIST

SYM	QTY	BOTANICAL NAME	COMMON NAME	SIZE	ROOT	COMMENTS
DECIDUOUS SHADE TREES						
AR	1	Acer rubrum 'October Glory'	October Glory Red Maple	2.5-3" cal.	B&B	Limb to 7' ht.
QA	1	Quercus alba	White Oak	2.5-3" cal.	B&B	Limb to 7' ht.
ORNAMENTAL TREES						
AL	1	Amelanchier laevis 'Snowcloud'	Snowcloud Serviceberry	2.5-3" cal.	B&B	Single Stem
PERENNIALS, ORNAMENTAL GRASSES & GROUNDCOVERS						
CR	210	Carex amphibia	Creek Sedge		PLUG	12" O.C. Spacing
HH	11	Hemerocallis 'Happy Returns'	Happy Returns Daylily	1 gal.	CONT	18" O.C. Spacing
HJ	11	Hemerocallis 'Joan Senior'	Joan Senior Daylily	1 gal.	CONT	18" O.C. Spacing

NOTES:

1. FOR PLANTING NOTES, REFER TO SHEET 230.
2. FOR MASTER PLANT LIST, REFER TO SHEET 256.
3. FOR LANDSCAPING DETAILS, REFER TO SHEETS 254-256.

**WATERTOWN
ROUTE 16 (MOUNT AUBURN STREET)**

STATE	FED. AID PROJ. NO.	SHEET NO.	TOTAL SHEETS
MA	-	242	391

PROJECT FILE NO. 607777

**LANDSCAPING PLAN
SHEET 13 OF 18**

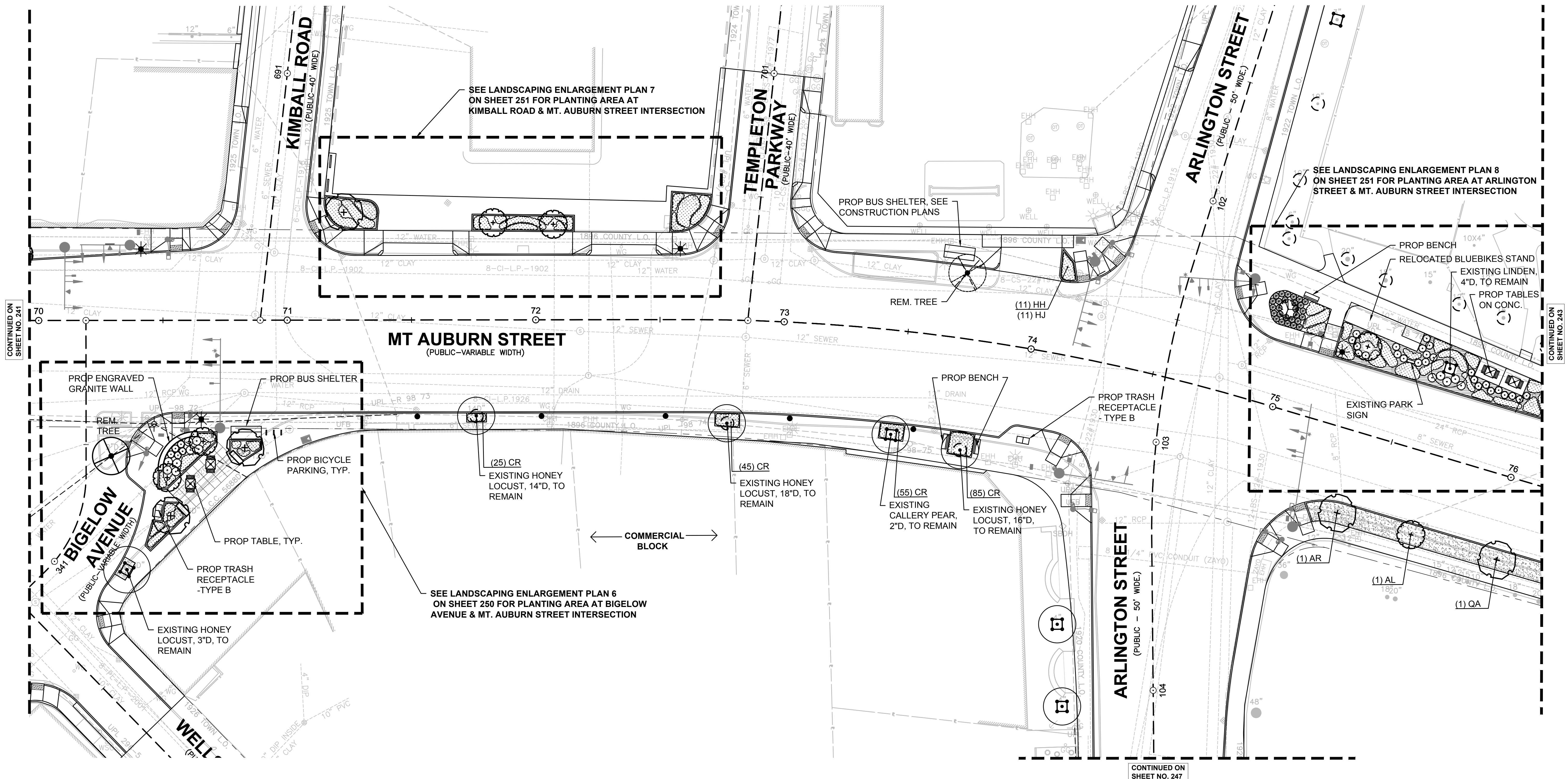
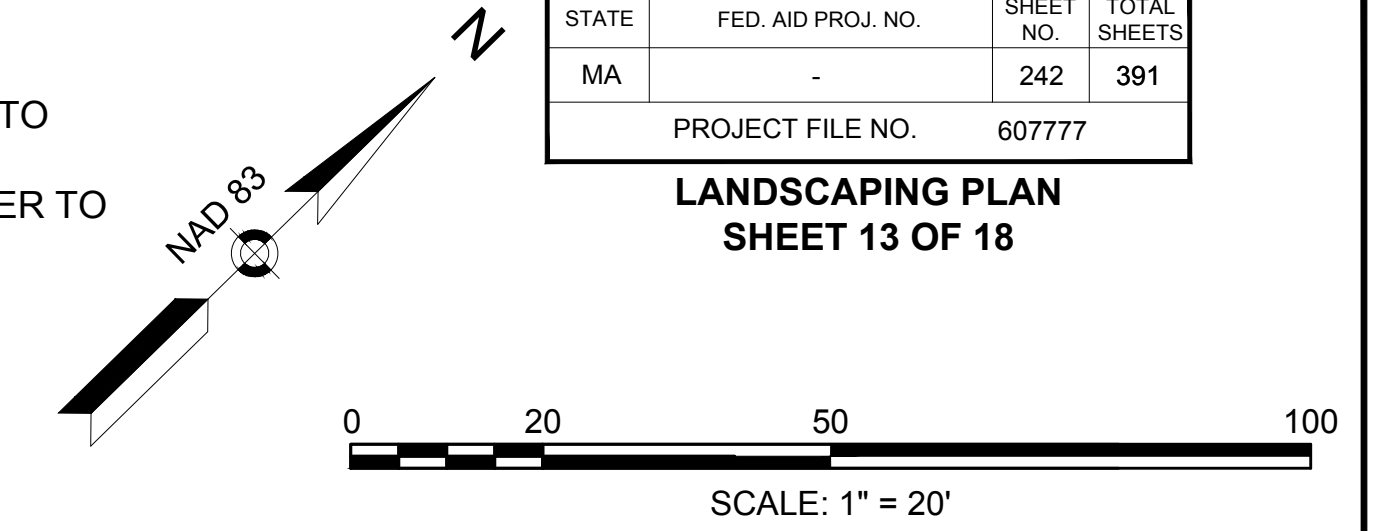









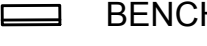



CONTINUED ON SHEET NO. 241

CONTINUED ON SHEET NO. 243

CONTINUED ON SHEET NO. 247

LEGEND

-  BENCH
-  TABLE
-  TRASH RECEPTACLE TYPE A
-  TRASH RECEPTACLE TYPE B
-  BICYCLE PARKING POST
-  EXISTING SMALL TREE WITH TREE PROTECTION (< 4" CAL.)
-  EXISTING LARGE TREE WITH TREE PROTECTION
-  PROPOSED DECIDUOUS SHADE TREE
-  PROPOSED ORNAMENTAL TREE
-  PROPOSED EVERGREEN TREE
-  PROPOSED SHRUBS
-  PROPOSED PERENNIALS, ORNAMENTAL GRASSES, & GROUNDCOVERS
-  LAWN

SHEET 14 PLANT LIST

SYM	QTY	BOTANICAL NAME	COMMON NAME	SIZE	ROOT	COMMENTS
DECIDUOUS SHADE TREES						
GB	1	Ginkgo biloba 'Princeton Sentry'	Princeton Sentry Maidenhair Tree	2.5-3" cal.	B&B	Limb to 7' ht.
LS	2	Liquidambar styraciflua 'Rotundiloba'	Rotundiloba Sweetgum (fruitless)	2.5-3" cal.	B&B	Limb to 7' ht.
NS	3	Nyssa sylvatica 'Wildfire'	Wildfire Sour Gum	2.5-3" cal.	B&B	Limb to 7' ht.
PA	2	Platanus x acerifolia 'Exclamation'	Exclamation London Planetree	2.5-3" cal.	B&B	Limb to 7' ht.
QA	1	Quercus alba	White Oak	2.5-3" cal.	B&B	Limb to 7' ht.
ORNAMENTAL TREES						
AL	1	Amelanchier laevis 'Snowcloud'	Snowcloud Serviceberry	2.5-3" cal.	B&B	Single Stem
CA	2	Cornus 'Aurora'	Aurora Dogwood	2.5-3" cal.	B&B	
MS	1	Malus 'Spring Snow'	Spring Snow Crabapple	2.5-3" cal.	B&B	Fruitless variety
PS	3	Prunus serrulata 'Kwanzan'	Kwanzan Japanese Cherry	2.5-3" cal.	B&B	
SHRUBS						
RA	30	Rhus aromatica 'Gro-Low'	Gro-Low Fragrant Sumac	2 gal.	CONT.	30" O.C. Spacing

NOTES:

1. FOR PLANTING NOTES, REFER TO SHEET 230.
2. FOR MASTER PLANT LIST, REFER TO SHEET 256.
3. FOR LANDSCAPING DETAILS, REFER TO SHEETS 254-256.

**WATERTOWN
ROUTE 16 (MOUNT AUBURN STREET)**

STATE	FED. AID PROJ. NO.	SHEET NO.	TOTAL SHEETS
MA	-	243	391
PROJECT FILE NO.		607777	



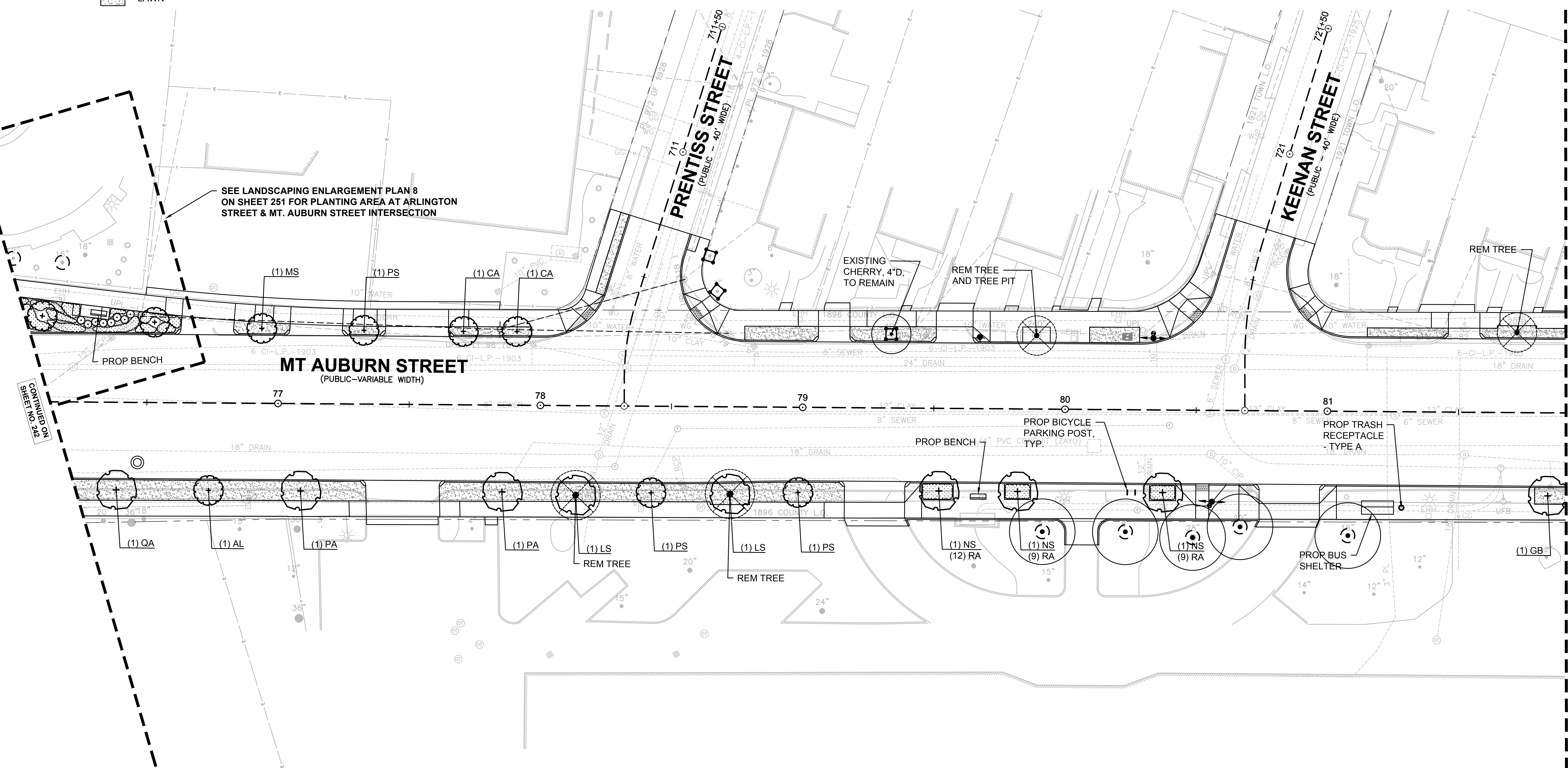
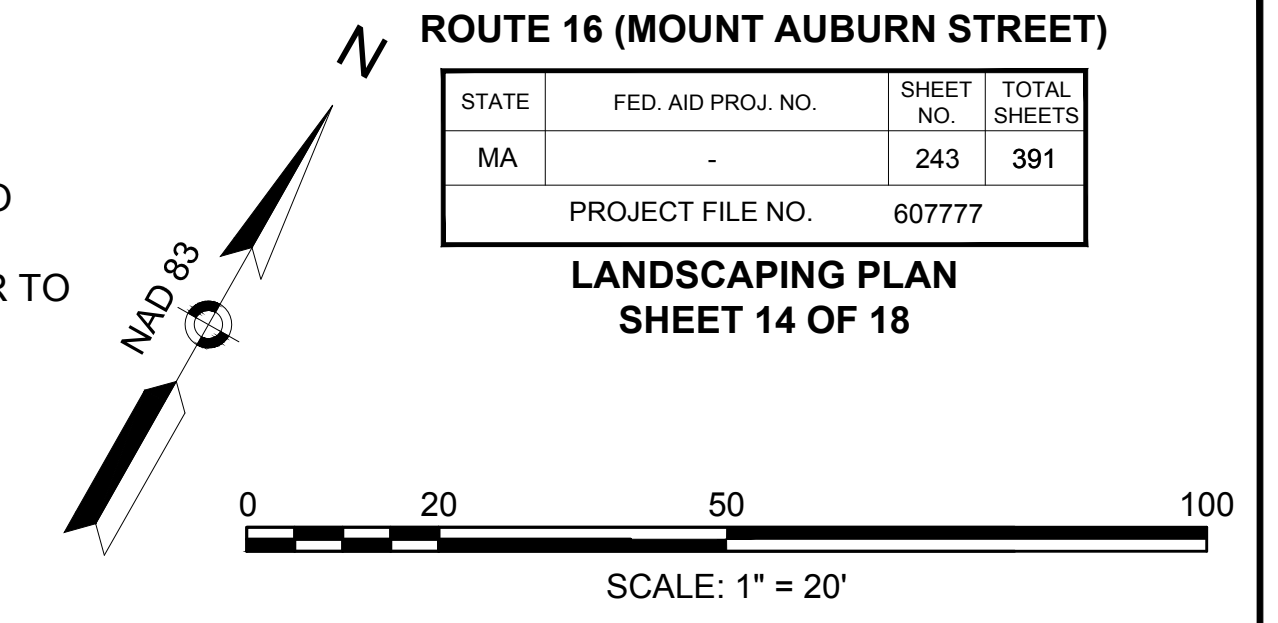







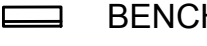

**LANDSCAPING PLAN
SHEET 14 OF 18**

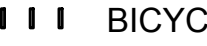

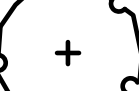
CONTINUED ON SHEET NO. 242

CONTINUED ON SHEET NO. 244

LEGEND

-  BENCH
-  TABLE
-  TRASH RECEPTACLE TYPE A
-  TRASH RECEPTACLE TYPE B
-  BICYCLE PARKING POST
-  EXISTING SMALL TREE WITH TREE PROTECTION (< 4" CAL.)
-  EXISTING LARGE TREE WITH TREE PROTECTION
-  PROPOSED DECIDUOUS SHADE TREE
-  PROPOSED ORNAMENTAL TREE
-  PROPOSED EVERGREEN TREE
-  PROPOSED SHRUBS
-  PROPOSED PERENNIALS, ORNAMENTAL GRASSES, & GROUNDCOVERS
-  LAWN

SHEET 15 PLANT LIST

SYM	QTY	BOTANICAL NAME	COMMON NAME	SIZE	ROOT	COMMENTS
DECIDUOUS SHADE TREES						
GB	4	Ginkgo biloba 'Princeton Sentry'	Princeton Sentry Maidenhair Tree	2.5-3" cal.	B&B	Limb to 7' ht.
LT	4	Liriodendron tulipifera 'Emerald City'	Emerald City Tulip Tree	2.5-3" cal.	B&B	Limb to 7' ht.
NS	1	Nyssa sylvatica 'Wildfire'	Wildfire Sour Gum	2.5-3" cal.	B&B	Limb to 7' ht.
ZS	3	Zelkova serrata 'Green Vase'	Green Vase Japanese Zelkova	2.5-3" cal.	B&B	Limb to 7' ht.
ORNAMENTAL TREES						
CC	2	Cercis canadensis	Eastern Redbud	2.5-3" cal.	B&B	Single stem
MA	1	Malus 'Adirondack'	Adirondack Crabapple	2.5-3" cal.	B&B	
PS	2	Prunus serrulata 'Kwanzan'	Kwanzan Japanese Cherry	2.5-3" cal.	B&B	
SHRUBS						
RA	12	Rhus aromatica 'Gro-Low'	Gro-Low Fragrant Sumac	2 gal.	CONT.	30" O.C. Spacing

NOTES:

1. FOR PLANTING NOTES, REFER TO SHEET 230.
2. FOR MASTER PLANT LIST, REFER TO SHEET 256.
3. FOR LANDSCAPING DETAILS, REFER TO SHEETS 254-256.

WATERTOWN
ROUTE 16 (MOUNT AUBURN STREET)

STATE	FED. AID PROJ. NO.	SHEET NO.	TOTAL SHEETS
MA	-	244	391
PROJECT FILE NO.		607777	

LANDSCAPING PLAN
SHEET 15 OF 18



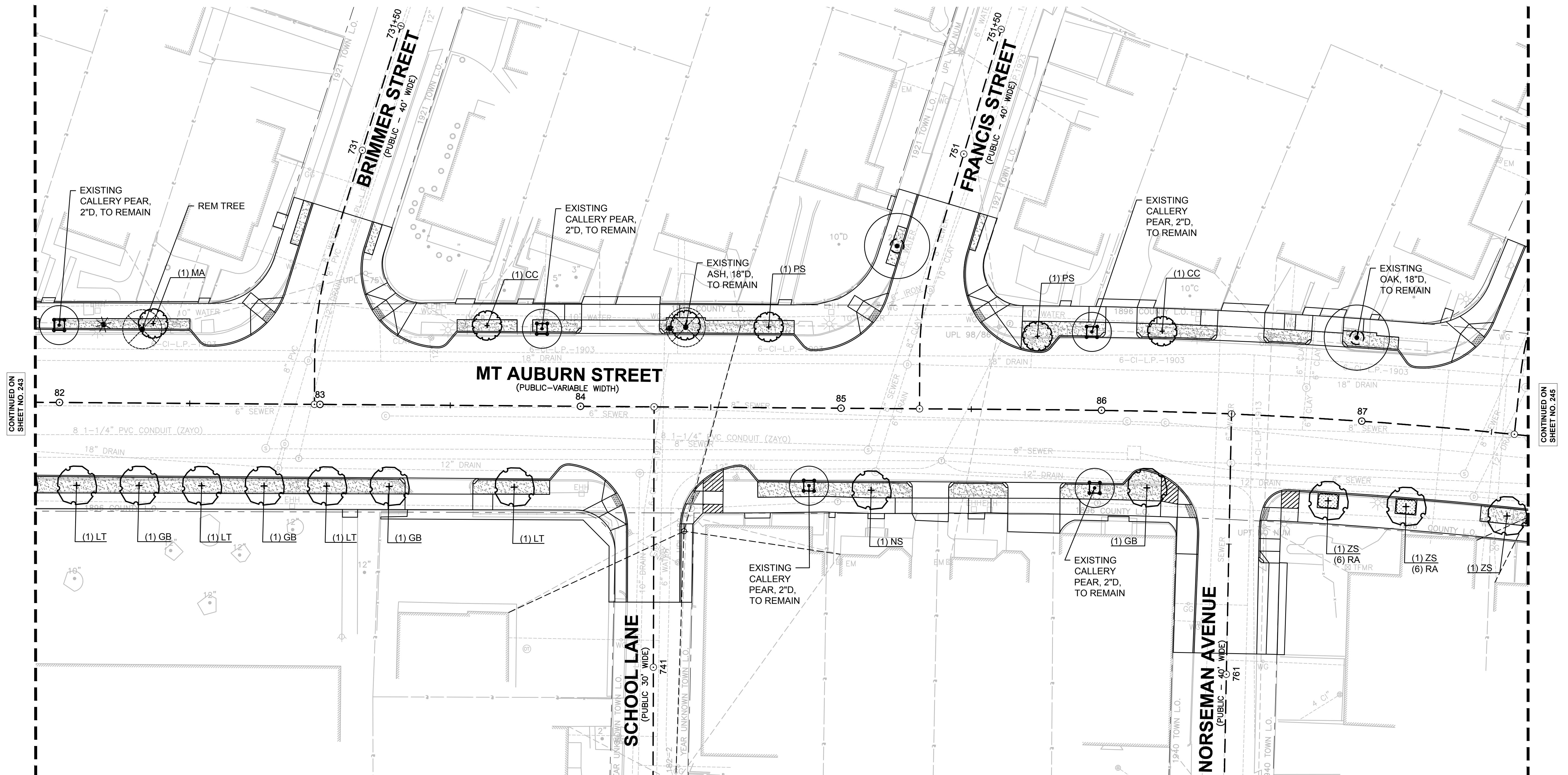









SCALE: 1" = 20'



CONTINUED ON SHEET NO. 243

CONTINUED ON SHEET NO. 245

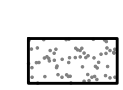
LEGEND

-  BENCH
-  TABLE
-  TRASH RECEPTACLE TYPE A
-  TRASH RECEPTACLE TYPE B
-  BICYCLE PARKING POST
-  EXISTING SMALL TREE WITH TREE PROTECTION (< 4" CAL.)
-  EXISTING LARGE TREE WITH TREE PROTECTION
-  PROPOSED DECIDUOUS SHADE TREE
-  PROPOSED ORNAMENTAL TREE
-  PROPOSED EVERGREEN TREE
-  PROPOSED SHRUBS
-  PROPOSED PERENNIALS, ORNAMENTAL GRASSES, & GROUNDCOVERS
-  LAWN

SHEET 16 PLANT LIST

SYM	QTY	BOTANICAL NAME	COMMON NAME	SIZE	ROOT	COMMENTS
DECIDUOUS SHADE TREES						
AF	1	<i>Acer x freemanii</i> 'Armstrong'	Armstrong Red Maple	2.5-3" cal.	B&B	Limb to 7' ht.
LS	3	<i>Liquidambar styraciflua</i> 'Rotundiloba'	Rotundiloba Sweetgum (fruitless)	2.5-3" cal.	B&B	Limb to 7' ht.
QA	2	<i>Quercus alba</i>	White Oak	2.5-3" cal.	B&B	Limb to 7' ht.
ZS	1	<i>Zelkova serrata</i> 'Green Vase'	Green Vase Japanese Zelkova	2.5-3" cal.	B&B	Limb to 7' ht.
ORNAMENTAL TREES						
AL	1	<i>Amelanchier laevis</i> 'Snowcloud'	Snowcloud Serviceberry	2.5-3" cal.	B&B	Single Stem
CC	1	<i>Cercis canadensis</i>	Eastern Redbud	2.5-3" cal.	B&B	Single Stem
MA	2	<i>Malus</i> 'Adirondack'	Adirondack Crabapple	2.5-3" cal.	B&B	
PC	3	<i>Prunus virginiana</i> 'Canada Red Select'	Canada Red Select Chokecherry	2.5-3" cal.	B&B	
SR	1	<i>Syringa reticulata</i> 'Ivory Silk'	Ivory Silk Japanese Tree Lilac	2.5-3" cal.	B&B	Single Stem
PERENNIALS, ORNAMENTAL GRASSES & GROUNDCOVERS						
CR	38	<i>Carex amphiloa</i>	Creek Sedge		PLUG	12" O.C. Spacing
VM	157	<i>Vinca minor</i> 'Bowles'	Bowles Periwinkle	4" pot	CONT.	12" O.C. Spacing

NOTES:

1. FOR PLANTING NOTES, REFER TO SHEET 230.
2. FOR MASTER PLANT LIST, REFER TO SHEET 256.
3. FOR LANDSCAPING DETAILS, REFER TO SHEETS 254-256.

WATERTOWN
ROUTE 16 (MOUNT AUBURN STREET)

STATE	FED. AID PROJ. NO.	SHEET NO.	TOTAL SHEETS
MA	-	245	391
PROJECT FILE NO.		607777	

LANDSCAPING PLAN
SHEET 16 OF 18

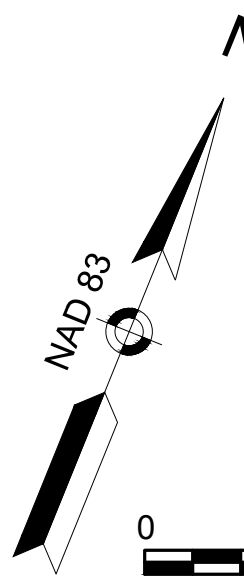
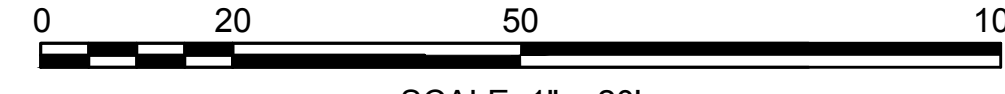



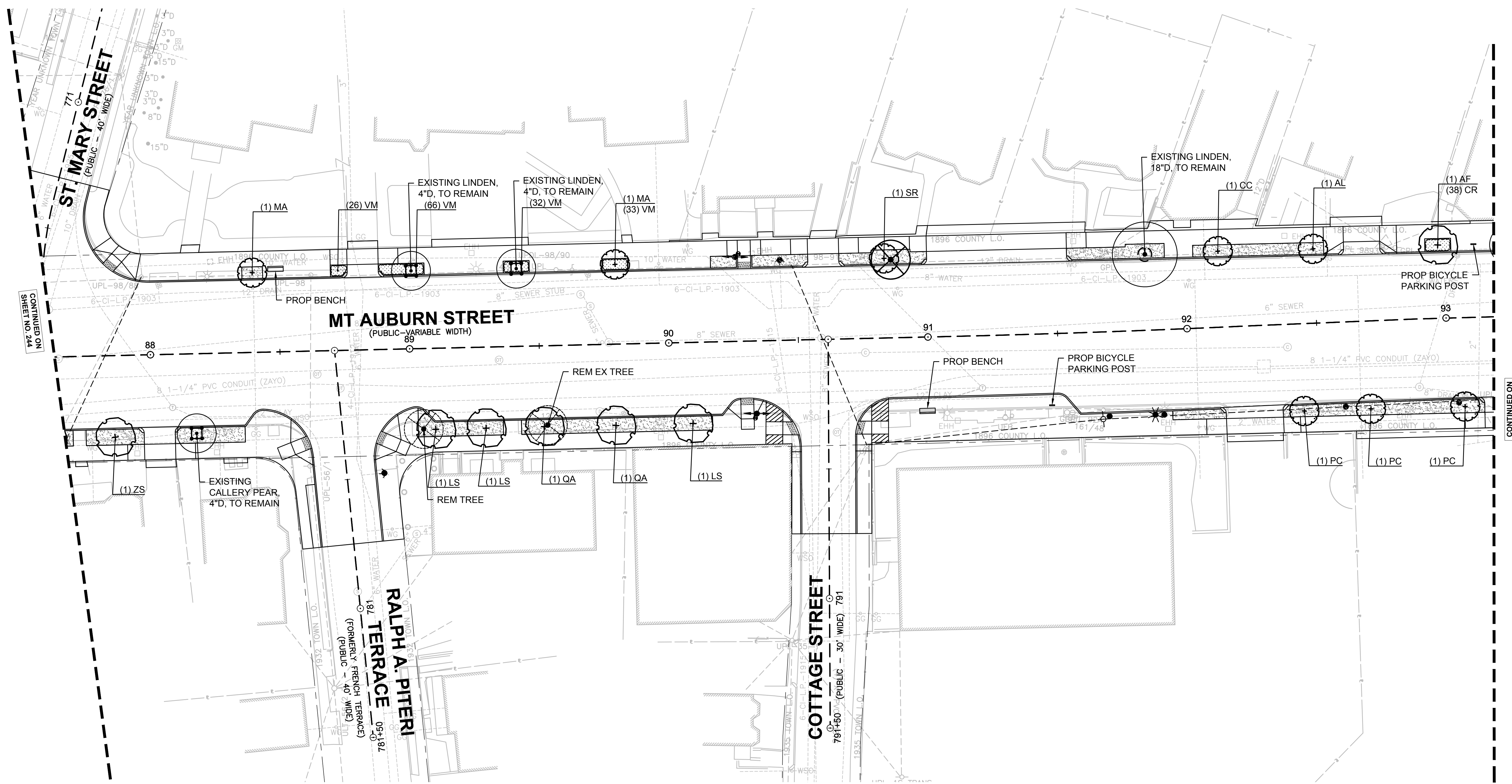





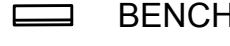

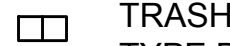
SCALE: 1" = 20'

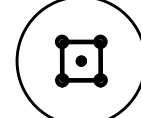

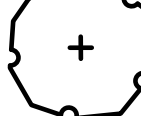
CONTINUED ON SHEET NO. 244

CONTINUED ON SHEET NO. 246

LEGEND

-  BENCH
-  TABLE
-  TRASH RECEPTACLE TYPE A
-  TRASH RECEPTACLE TYPE B
-  BICYCLE PARKING POST
-  EXISTING SMALL TREE WITH TREE PROTECTION (< 4" CAL.)
-  EXISTING LARGE TREE WITH TREE PROTECTION
-  PROPOSED DECIDUOUS SHADE TREE
-  PROPOSED ORNAMENTAL TREE
-  PROPOSED EVERGREEN TREE
-  PROPOSED SHRUBS
-  PROPOSED PERENNIALS, ORNAMENTAL GRASSES, & GROUNDCOVERS
-  LAWN

SHEET 17 PLANT LIST

SYM	QTY	BOTANICAL NAME	COMMON NAME	SIZE	ROOT	COMMENTS
DECIDUOUS SHADE TREES						
AF	2	Acer x freemanii 'Armstrong'	Armstrong Red Maple	2.5-3" cal.	B&B	Limb to 7' ht.
ORNAMENTAL TREES						
MA	2	Malus 'Adirondack'	Adirondack Crabapple	2.5-3" cal.	B&B	
PERENNIALS, ORNAMENTAL GRASSES & GROUNDCOVERS						
CR	112	Carex amphibola	Creek Sedge		PLUG	12" O.C. Spacing
VM	90	Vinca minor 'Bowles'	Bowles Periwinkle	4" pot	CONT.	12" O.C. Spacing

NOTES:

1. FOR PLANTING NOTES, REFER TO SHEET 230.
2. FOR MASTER PLANT LIST, REFER TO SHEET 256.
3. FOR LANDSCAPING DETAILS, REFER TO SHEETS 254-256.

**WATERTOWN
ROUTE 16 (MOUNT AUBURN STREET)**

STATE	FED. AID PROJ. NO.	SHEET NO.	TOTAL SHEETS
MA	-	246	391
PROJECT FILE NO.		607777	



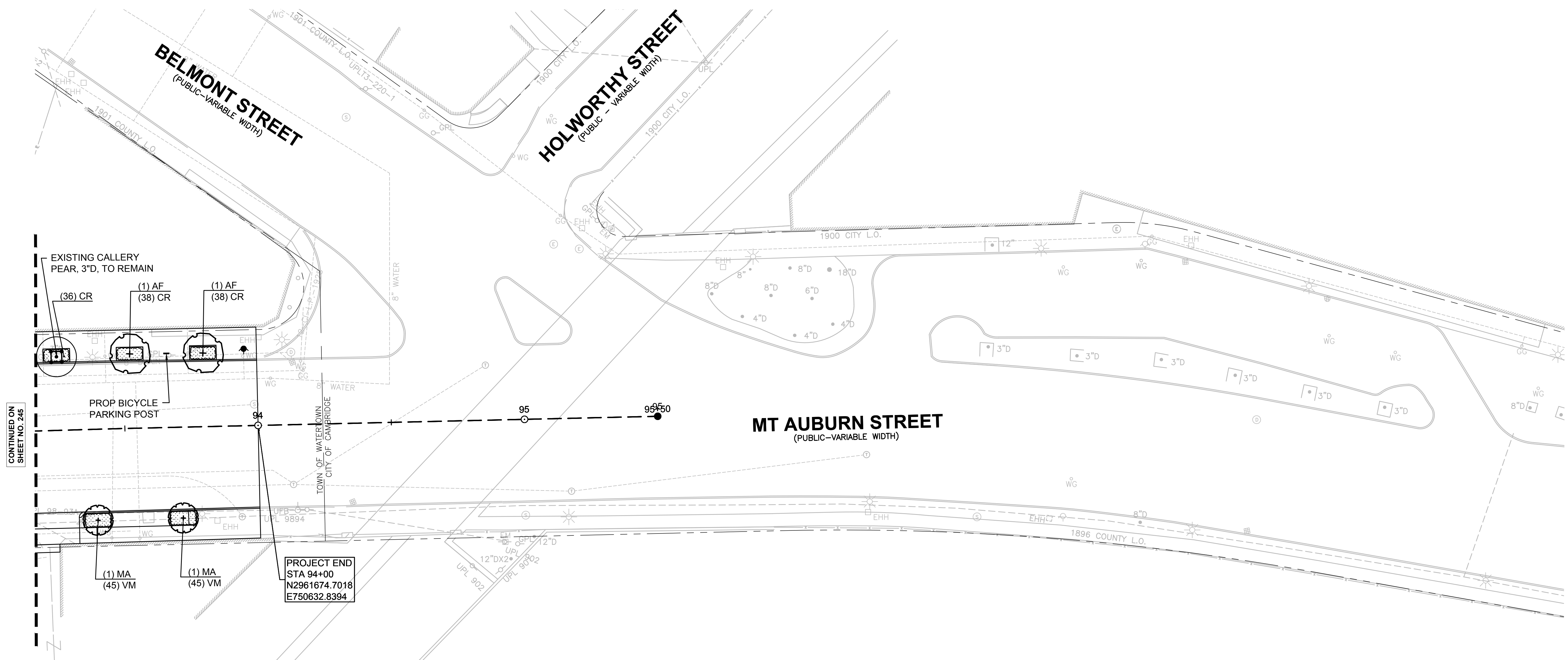
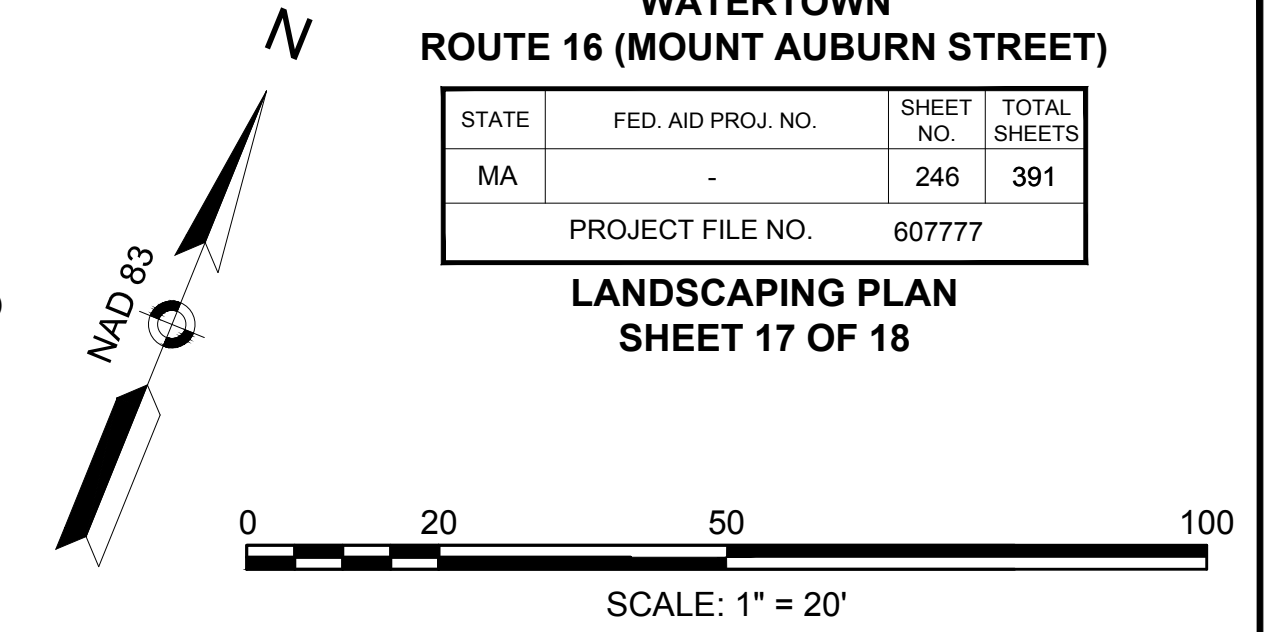





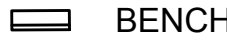

**LANDSCAPING PLAN
SHEET 17 OF 18**

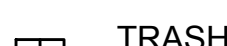

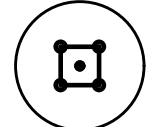
CONTINUED ON SHEET NO. 245

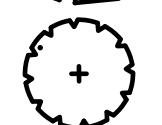
PROJECT END
STA 94+00
N2961674.7018
E750632.8394

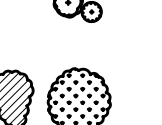
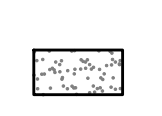
LEGEND

-  BENCH
-  TABLE
-  TRASH RECEPTACLE TYPE A
-  TRASH RECEPTACLE TYPE B
-  BICYCLE PARKING POST
-  EXISTING SMALL TREE WITH TREE PROTECTION (< 4" CAL.)
-  EXISTING LARGE TREE WITH TREE PROTECTION
-  PROPOSED DECIDUOUS SHADE TREE
-  PROPOSED ORNAMENTAL TREE
-  PROPOSED EVERGREEN TREE
-  PROPOSED SHRUBS
-  PROPOSED PERENNIALS, ORNAMENTAL GRASSES, & GROUNDCOVERS
-  LAWN

NOTES:

1. FOR PLANTING NOTES, REFER TO SHEET 230.
2. FOR MASTER PLANT LIST, REFER TO SHEET 256.
3. FOR LANDSCAPING DETAILS, REFER TO SHEETS 254-256.

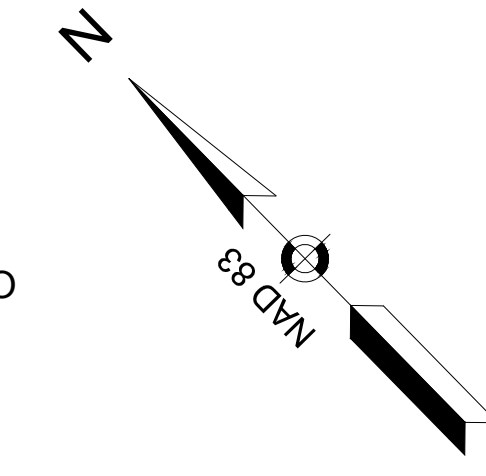

**WATERTOWN
ROUTE 16 (MOUNT AUBURN STREET)**

STATE	FED. AID PROJ. NO.	SHEET NO.	TOTAL SHEETS
MA	-	247	391

**LANDSCAPING PLAN
SHEET 18 OF 18**

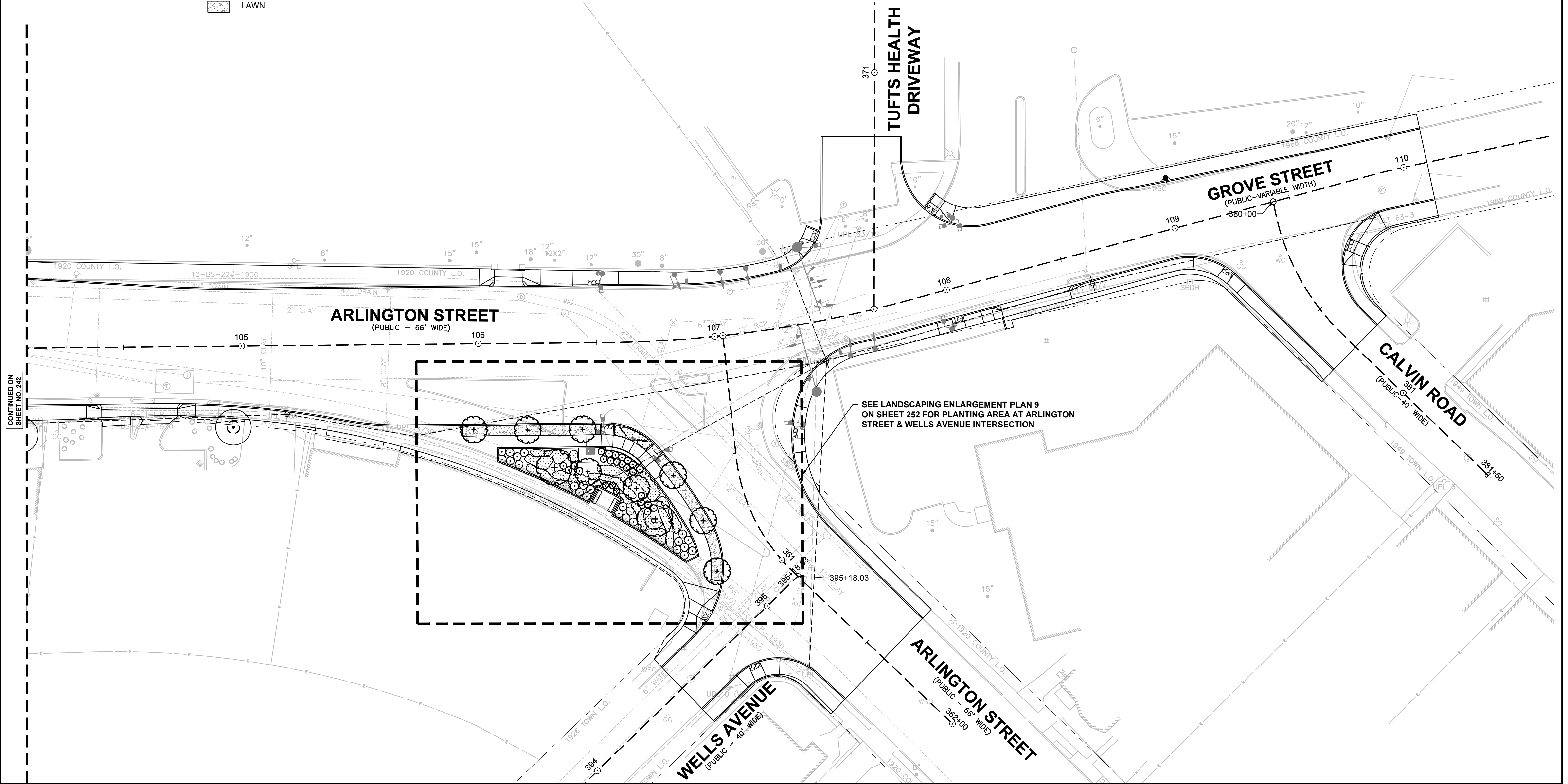
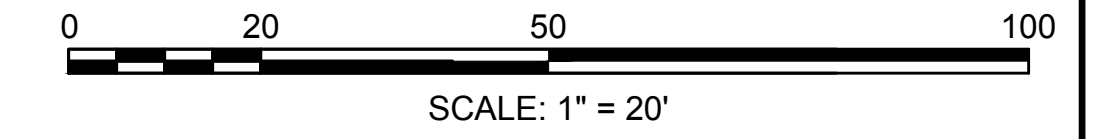

CONTINUED ON SHEET NO. 242

SEE LANDSCAPING ENLARGEMENT PLAN 9 ON SHEET 252 FOR PLANTING AREA AT ARLINGTON STREET & WELLS AVENUE INTERSECTION

LEGEND

- BENCH
- TABLE
- TRASH RECEPTACLE TYPE A
- TRASH RECEPTACLE TYPE B
- BICYCLE PARKING POST
- EXISTING SMALL TREE WITH TREE PROTECTION (< 4" CAL.)
- EXISTING LARGE TREE WITH TREE PROTECTION
- PROPOSED DECIDUOUS SHADE TREE
- PROPOSED ORNAMENTAL TREE
- PROPOSED EVERGREEN TREE
- PROPOSED SHRUBS
- PROPOSED PERENNIALS, ORNAMENTAL GRASSES, & GROUNDCOVERS
- LAWN

NOTES:

1. FOR PLANTING NOTES, REFER TO SHEET 230.
2. FOR MASTER PLANT LIST, REFER TO SHEET 256.
3. FOR LANDSCAPING DETAILS, REFER TO SHEETS 254-256.

WATERTOWN
ROUTE 16 (MOUNT AUBURN STREET)

STATE	FED. AID PROJ. NO.	SHEET NO.	TOTAL SHEETS
MA	-	248	391
PROJECT FILE NO. 607777			

LANDSCAPING ENLARGEMENT PLANS
SHEET 1 OF 6

SCALE: 1" = 10'

ENLARGEMENT 1 PLANT LIST

SYM	QTY	BOTANICAL NAME	COMMON NAME	SIZE	ROOT	COMMENTS
ORNAMENTAL TREES						
CA	1	Cornus 'Aurora'	Aurora Dogwood	2.5-3" cal.	B&B.	
SR	1	Syringa reticulata 'Ivory Silk'	Ivory Silk Japanese Tree Lilac	2.5-3" cal.	B&B.	Single Stem
SHRUBS						
HQ	8	Hydrangea quercifolia 'Pee Wee'	Pee Wee Oakleaf Hydrangea	18-24" ht.	CONT.	
PF	9	Potentilla fruticosa 'Pink Beauty'	Pink Beauty Shrubby Cinquefoil	18-24" ht.	CONT.	
PERENNIALS, ORNAMENTAL GRASSES, & GROUNDCOVERS						
AT	30	Amsonia tabernaemontana 'Blue Ice'	Blue Ice Blue Star Flower	1 gal.	CONT.	18" O.C. Spacing
CR	470	Carex amphiloba	Creek Sedge		PLUG	12" O.C. Spacing
EP	31	Echinacea purpurea 'Magnus'	Magnus Purple Coneflower	1 gal.	CONT.	18" O.C. Spacing
HM	8	Helenium 'Mardi Gras'	Mardi Gras Sneezeweed	1 gal.	CONT.	18" O.C. Spacing
IV	28	Iris versicolor	Blue Flag Iris	1 gal.	CONT.	24" O.C. Spacing
PD	50	Penstemon digitalis	Beardtongue	1 gal.	CONT.	18" O.C. Spacing
RG	67	Rudbeckia fulgida 'Goldsturm'	Goldsturm Black-Eyed Susan	1 gal.	CONT.	18" O.C. Spacing
SH	31	Sporobolus heterolepis	Prairie Dropseed	1 gal.	CONT.	24" O.C. Spacing

ENLARGEMENT 2 PLANT LIST

SYM	QTY	BOTANICAL NAME	COMMON NAME	SIZE	ROOT	COMMENTS
ORNAMENTAL TREES						
CA	1	Cornus 'Aurora'	Aurora Dogwood	2.5-3" cal.	B&B.	
SHRUBS						
CS	6	Cornus sericea 'Arctic Fire'	Arctic Fire Red Twig Dogwood	18-24" ht.	CONT.	
JC	6	Juniperus communis var. depressa 'AmiDak'	Blueberry Delight Common Juniper	2 gal.	CONT.	
PERENNIALS, ORNAMENTAL GRASSES, & GROUNDCOVERS						
AT	17	Amsonia tabernaemontana 'Blue Ice'	Blue Ice Blue Star Flower	1 gal.	CONT.	18" O.C. Spacing
CR	220	Carex amphiloba	Creek Sedge		PLUG	12" O.C. Spacing
EJ	14	Eutrochium dubium 'Little Joe'	Little Joe Joe Pye Weed	1 gal.	CONT.	18" O.C. Spacing
HM	14	Helenium 'Mardi Gras'	Mardi Gras Sneezeweed	1 gal.	CONT.	18" O.C. Spacing
LK	16	Liatris spicata 'Kobold'	Kobold Blazing Star	1 gal.	CONT.	18" O.C. Spacing
RG	12	Rudbeckia fulgida 'Goldsturm'	Goldsturm Black-Eyed Susan	1 gal.	CONT.	18" O.C. Spacing

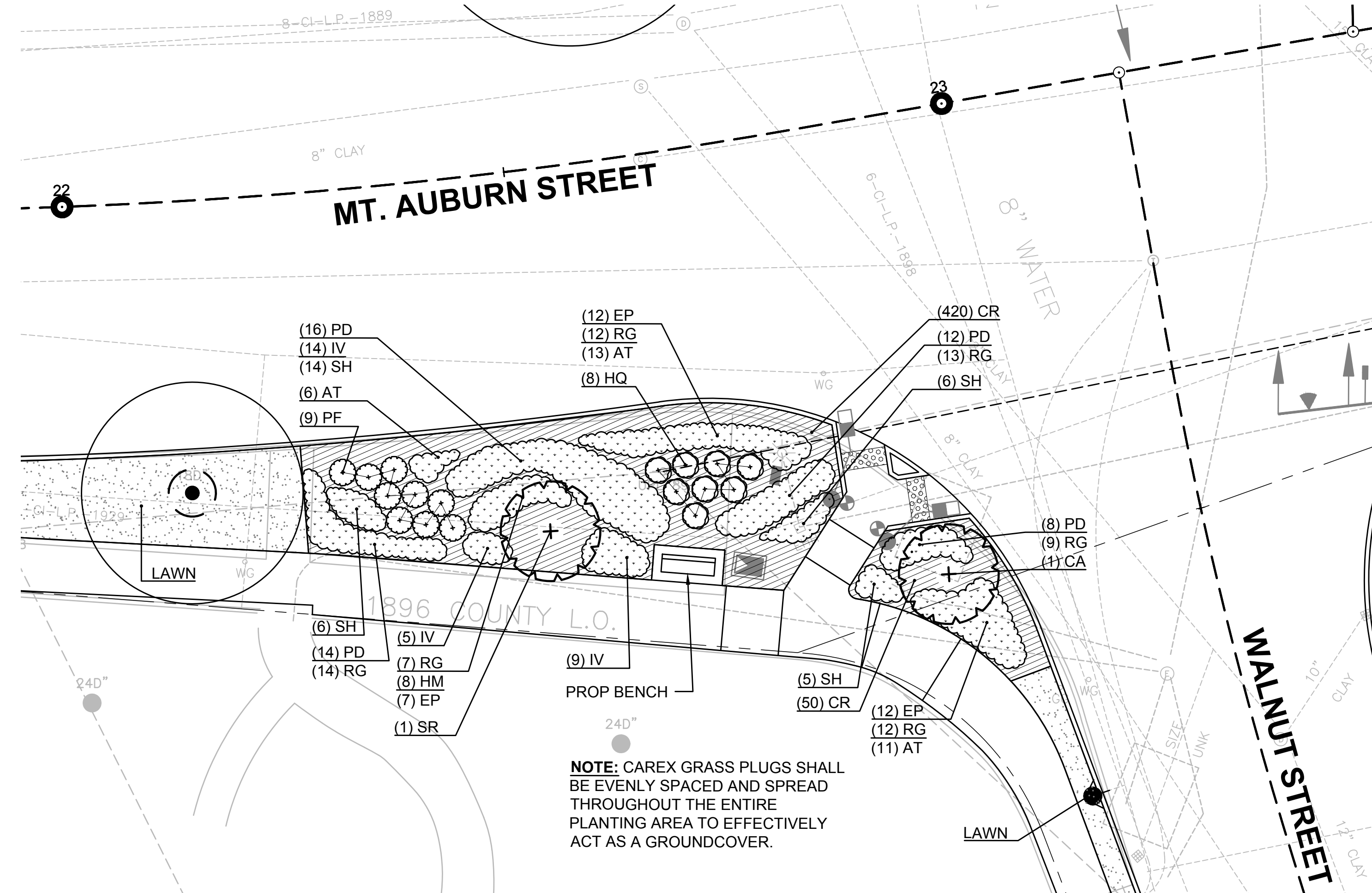

1 PLANTING AREA AT WALNUT STREET & MT. AUBURN STREET INTERSECTION
SCALE: 1"=10'-0"

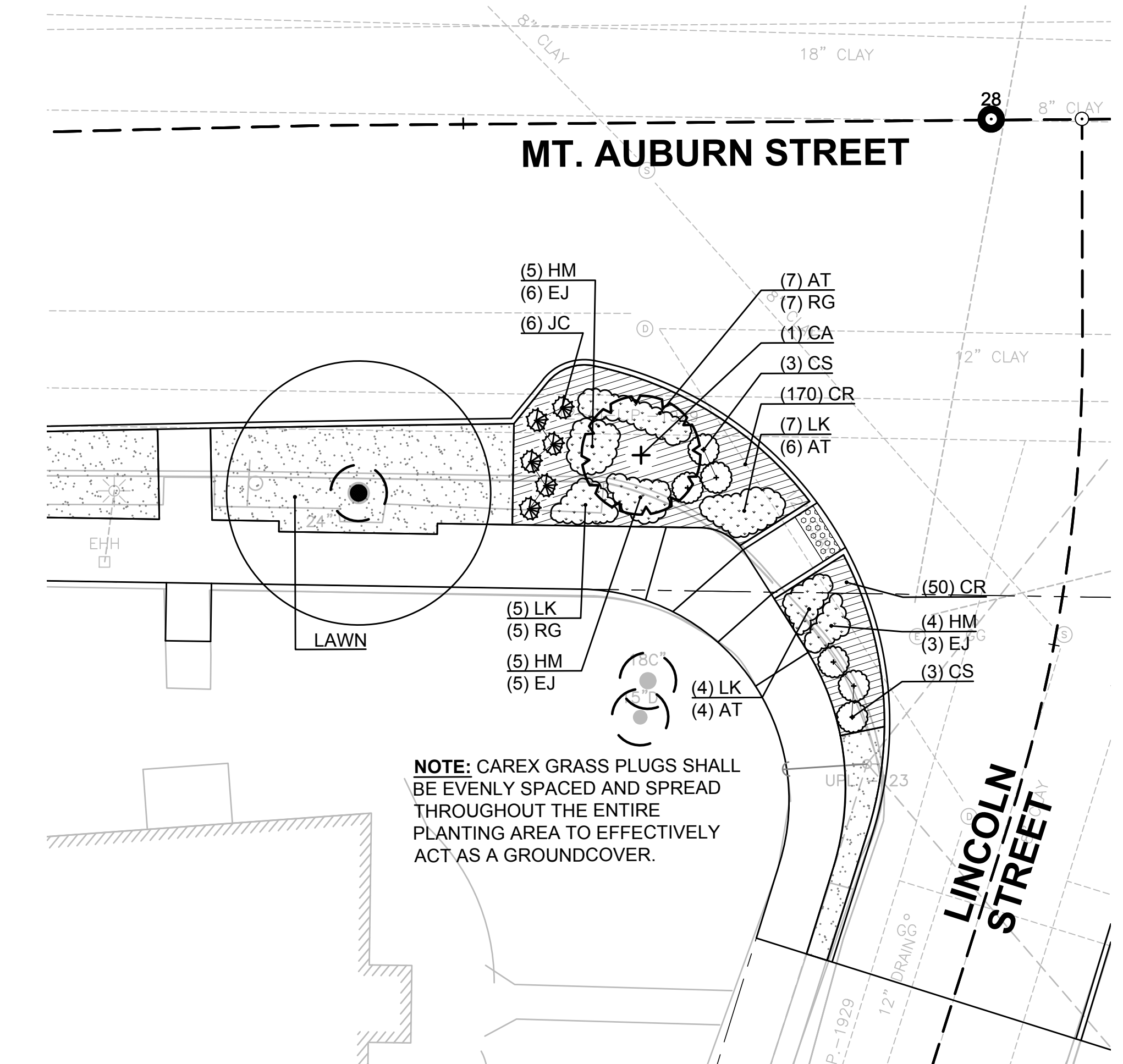

2 PLANTING AREA AT LINCOLN STREET & MT. AUBURN STREET INTERSECTION
SCALE: 1"=10'-0"

LEGEND

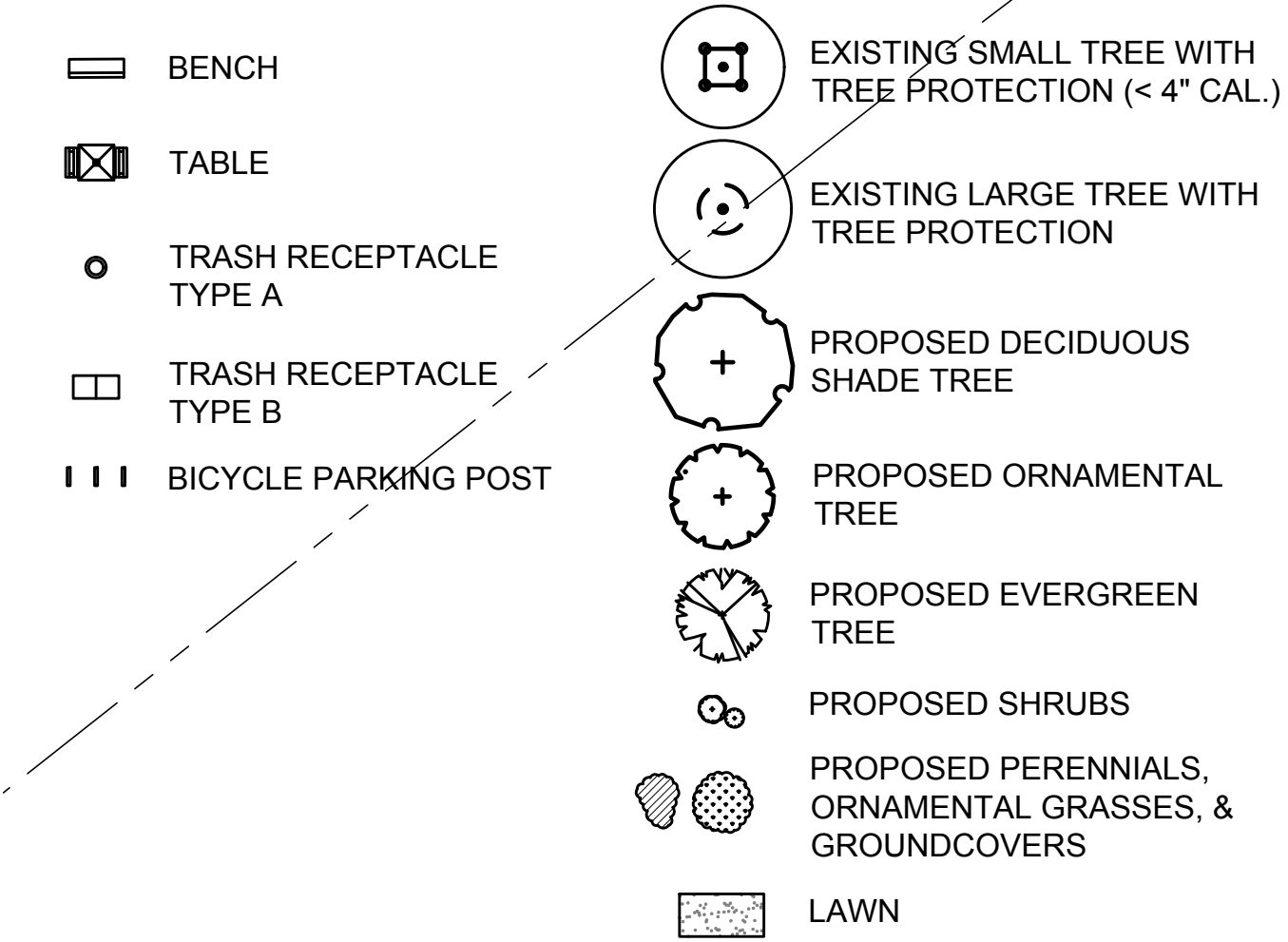

ENLARGEMENT 3 PLANT LIST

SYM	QTY	BOTANICAL NAME	COMMON NAME	SIZE	ROOT	COMMENTS
DECIDUOUS SHADE TREES						
LS	2	Liquidambar styraciflua 'Rotundiloba'	Rotundiloba Sweetgum (fruitless)	2.5-3" cal.	B&B	Limb to 7' ht.
ORNAMENTAL TREES						
SR	1	Syringa reticulata 'Ivory Silk'	Ivory Silk Japanese Tree Lilac	2.5-3" cal.	B&B	Single Stem
SHRUBS						
JC	12	Juniperus communis var. depressa 'AmiDak'	Blueberry Delight Common Juniper	2 gal.	CONT.	
PERENNIALS, ORNAMENTAL GRASSES, & GROUNDCOVERS						
GR	24	Geranium x 'Rozanne'	Rozanne Hardy Geranium	1 gal.	CONT.	18" O.C. Spacing
HJ	28	Hemerocallis 'Joan Senior'	Joan Senior Daylily	1 gal.	CONT.	18" O.C. Spacing
NF	26	Nepeta x faassenii 'Junior Walker'	Junior Walker Catmint	1 gal.	CONT.	18" O.C. Spacing

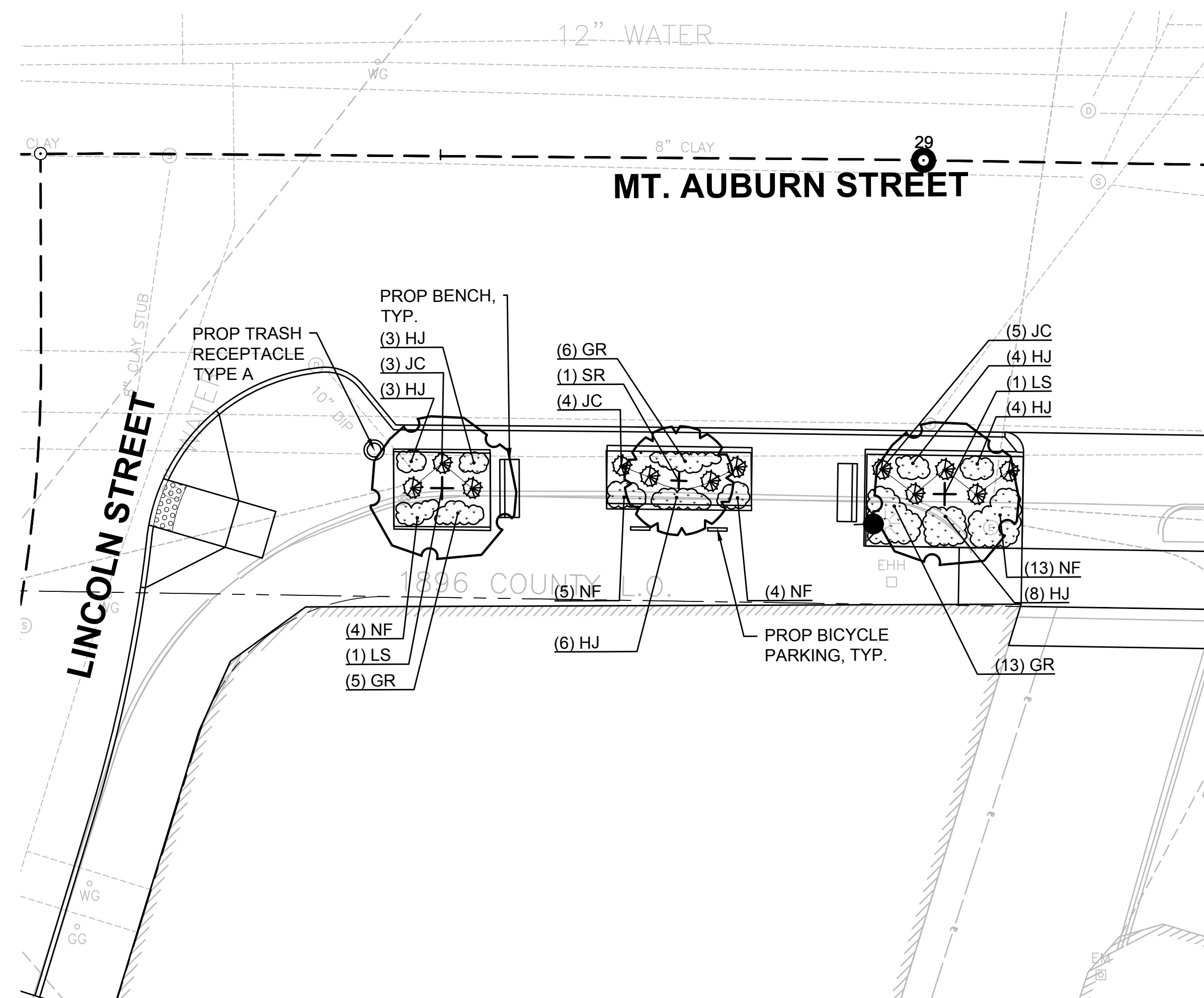

3 PLANTING AREA AT LINCOLN STREET & MT. AUBURN STREET INTERSECTION
SCALE: 1"=10'-0"

NOTES:

- FOR PLANTING NOTES, REFER TO SHEET 230.
- FOR MASTER PLANT LIST, REFER TO SHEET 256.
- FOR LANDSCAPING DETAILS, REFER TO SHEETS 254-256.

WATERTOWN ROUTE 16 (MOUNT AUBURN STREET)

STATE	FED. AID PROJ. NO.	SHEET NO.	TOTAL SHEETS
MA	-	249	391
PROJECT FILE NO.		607777	

LANDSCAPING ENLARGEMENT PLANS SHEET 2 OF 6

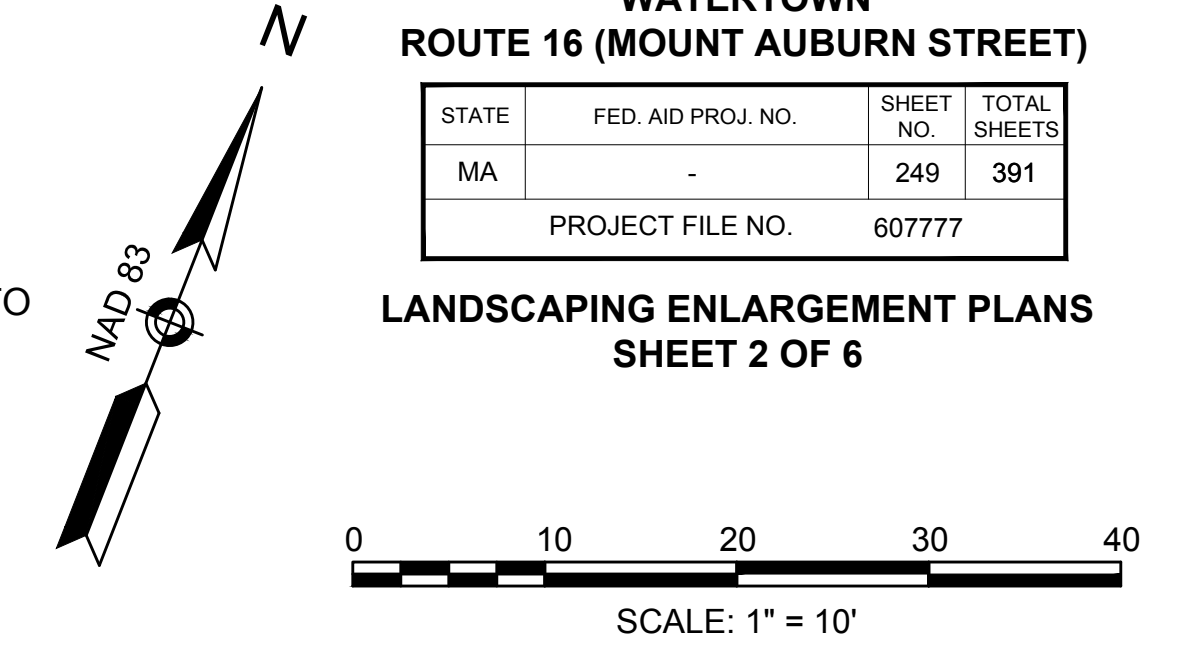

ENLARGEMENT 4 PLANT LIST

SYM	QTY	BOTANICAL NAME	COMMON NAME	SIZE	ROOT	COMMENTS
ORNAMENTAL TREES						
SR	1	Syringa reticulata 'Ivory Silk'	Ivory Silk Japanese Tree Lilac	2.5-3" cal.	B&B	Single Stem
SHRUBS						
RA	45	Rhus aromatica 'Gro-Low'	Gro-Low Fragrant Sumac	2 gal.	CONT.	30" O.C. Spacing
PERENNIALS, ORNAMENTAL GRASSES, & GROUNDCOVERS						
AT	12	Amsonia tabernaemontana 'Blue Ice'	Blue Ice Blue Star Flower	1 gal.	CONT.	18" O.C. Spacing
CR	160	Carex amphiloeba	Creek Sedge		PLUG	12" O.C. Spacing
GR	47	Geranium x 'Rozanne'	Rozanne Hardy Geranium	1 gal.	CONT.	18" O.C. Spacing
IV	12	Iris versicolor	Blue Flag Iris	1 gal.	CONT.	24" O.C. Spacing
LK	23	Liatris spicata 'Kobold'	Kobold Blazing Star	1 gal.	CONT.	18" O.C. Spacing
PL	22	Perovskia atriplicifolia 'Little Spire'	Little Spire Russian Sage	1 gal.	CONT.	24" O.C. Spacing
RG	45	Rudbeckia fulgida 'Goldsturm'	Goldsturm Black-Eyed Susan	1 gal.	CONT.	18" O.C. Spacing

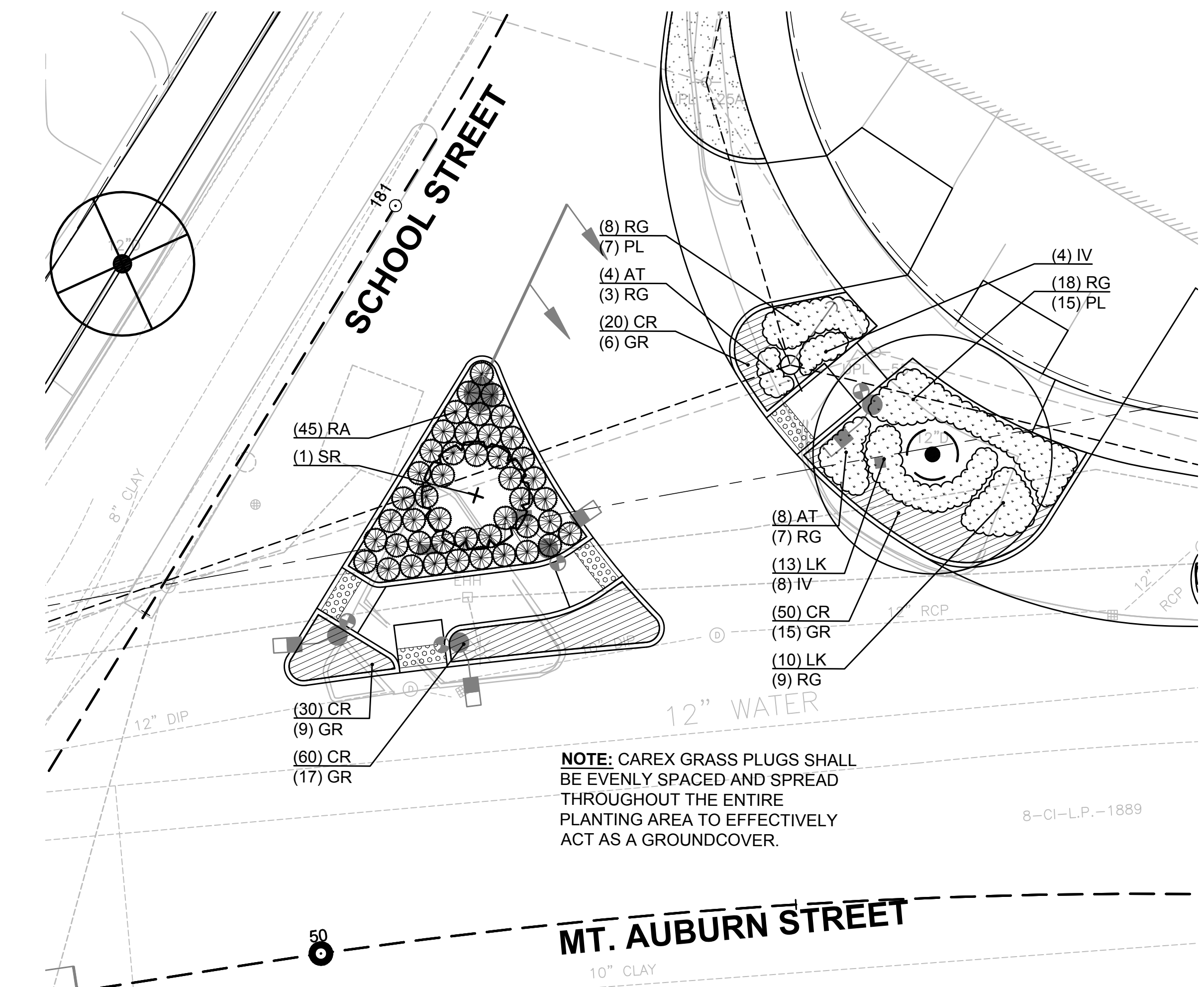

4 PLANTING AREA AT SCHOOL STREET & MT. AUBURN STREET INTERSECTION
SCALE: 1"=10'-0"

LEGEND

- BENCH
- TABLE
- TRASH RECEPTACLE TYPE A
- TRASH RECEPTACLE TYPE B
- BICYCLE PARKING POST
- EXISTING SMALL TREE WITH TREE PROTECTION (< 4" CAL.)
- EXISTING LARGE TREE WITH TREE PROTECTION
- PROPOSED DECIDUOUS SHADE TREE
- PROPOSED ORNAMENTAL TREE
- PROPOSED EVERGREEN TREE
- PROPOSED SHRUBS
- PROPOSED PERENNIALS, ORNAMENTAL GRASSES, & GROUNDCOVERS
- LAWN

ENLARGEMENT 5 PLANT LIST

SYM	QTY	BOTANICAL NAME	COMMON NAME	SIZE	ROOT	COMMENTS
DECIDUOUS SHADE TREES						
GT	2	Gleditsia triacanthos v. inermis 'Skyline'	Skyline Honeylocust	2.5-3" cal.	B&B	Limb to 7' ht.
ORNAMENTAL TREES						
AL	3	Amelanchier laevis 'Snowcloud'	Snowcloud Serviceberry	2.5-3" cal.	B&B	Single Stem
CC	2	Cercis canadensis	Eastern Redbud	2.5-3" cal.	B&B	Single Stem
SHRUBS						
HQ	15	Hydrangea quercifolia 'Pee Wee'	Pee Wee Oakleaf Hydrangea	18-24" ht.	CONT.	
IG	13	Ilex glabra 'Shamrock'	Shamrock Inkberry	24-30" ht.	CONT.	
PERENNIALS, ORNAMENTAL GRASSES, & GROUNDCOVERS						
GR	38	Geranium x 'Rozanne'	Rozanne Hardy Geranium	1 gal.	CONT.	18" O.C. Spacing
HH	19	Hemerocallis 'Happy Returns'	Happy Returns Daylily	1 gal.	CONT.	18" O.C. Spacing
HJ	26	Hemerocallis 'Joan Senior'	Joan Senior Daylily	1 gal.	CONT.	18" O.C. Spacing
NF	58	Nepeta x faassenii 'Junior Walker'	Junior Walker Catmint	1 gal.	CONT.	18" O.C. Spacing
PV	10	Panicum virgatum 'Shenandoah'	Shenandoah Switchgrass	2 gal.	CONT.	24" O.C. Spacing
PL	21	Perovskia atriplicifolia 'Little Spire'	Little Spire Russian Sage	1 gal.	CONT.	24" O.C. Spacing
SS	35	Schizachyrium scoparium 'Standing Ovation'	Little Bluestem	1 gal.	CONT.	18" O.C. Spacing

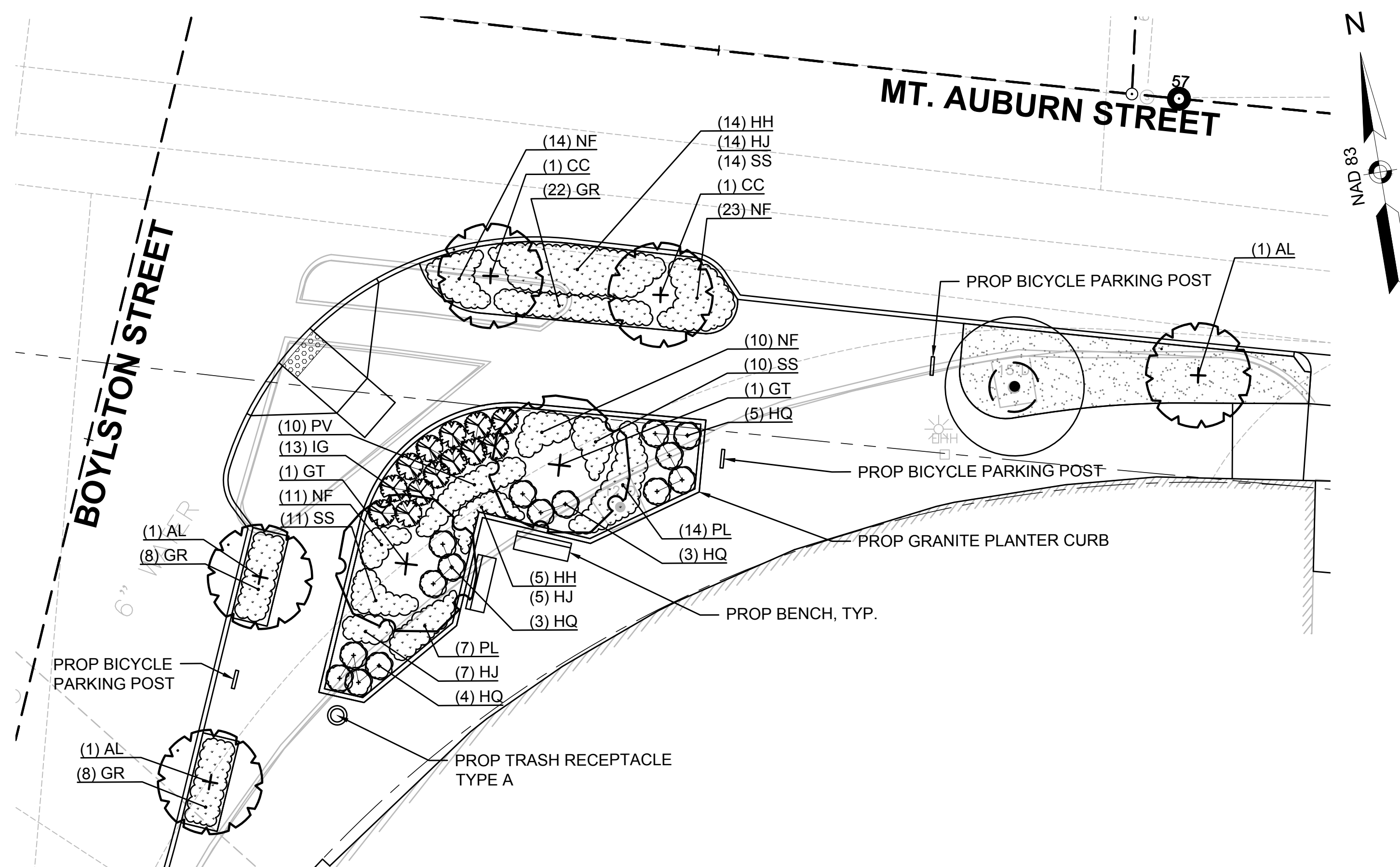

5 PLANTING AREA AT BOYLSTON STREET & MT. AUBURN STREET INTERSECTION (WEST)
SCALE: 1"=10'-0"

NOTES:

- FOR PLANTING NOTES, REFER TO SHEET 230.
- FOR MASTER PLANT LIST, REFER TO SHEET 256.
- FOR LANDSCAPING DETAILS, REFER TO SHEETS 254-256.

WATERTOWN
ROUTE 16 (MOUNT AUBURN STREET)

STATE	FED. AID PROJ. NO.	SHEET NO.	TOTAL SHEETS
MA	-	250	391
PROJECT FILE NO. 607777			

LANDSCAPING ENLARGEMENT PLANS
SHEET 3 OF 6

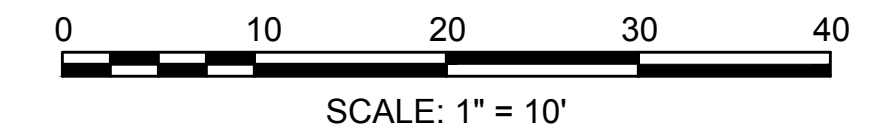

ENLARGEMENT 6 PLANT LIST

SYM	QTY	BOTANICAL NAME	COMMON NAME	SIZE	ROOT	COMMENTS
DECIDUOUS SHADE TREES						
NS	2	Nyssa sylvatica 'Wildfire'	Wildfire Sour Gum	2.5-3" cal.	B&B	Limb to 7' ht.
ORNAMENTAL TREES						
PS	2	Prunus serrulata 'Kwanzan'	Kwanzan Japanese Cherry	2.5-3" cal.	B&B	
SHRUBS						
CS	8	Cornus sericea 'Arctic Fire'	Arctic Fire Red Twig Dogwood	18-24" ht.	CONT.	
HQ	5	Hydrangea quercifolia 'Pee Wee'	Pee Wee Oakleaf Hydrangea	18-24" ht.	CONT.	
PERENNIALS, ORNAMENTAL GRASSES, & GROUNDCOVERS						
GR	23	Geranium x 'Rozanne'	Rozanne Hardy Geranium	1 gal.	CONT.	18" O.C. Spacing
HH	14	Hemerocallis 'Happy Returns'	Happy Returns Daylily	1 gal.	CONT.	18" O.C. Spacing
HJ	14	Hemerocallis 'Joan Senior'	Joan Senior Daylily	1 gal.	CONT.	18" O.C. Spacing
NF	27	Nepeta x faassenii 'Junior Walker'	Junior Walker Catmint	1 gal.	CONT.	18" O.C. Spacing
PV	13	Panicum virgatum 'Shenandoah'	Shenandoah Switchgrass	2 gal.	CONT.	24" O.C. Spacing

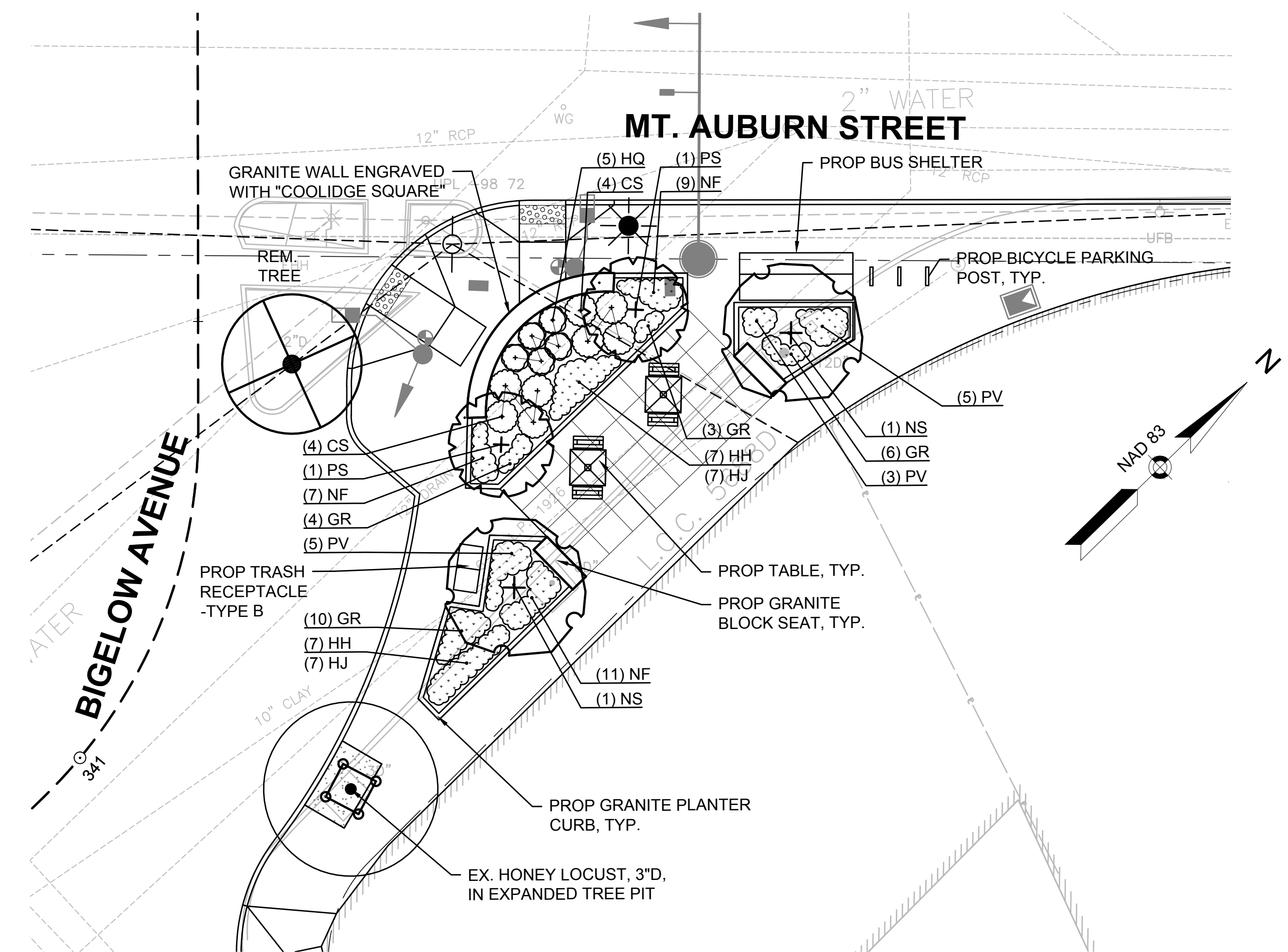

6 PLANTING AREA AT BIGELOW AVENUE & MT. AUBURN STREET INTERSECTION
SCALE: 1"=10'-0"

LEGEND

- BENCH
- TABLE
- TRASH RECEPTACLE TYPE A
- TRASH RECEPTACLE TYPE B
- BICYCLE PARKING POST
- EXISTING SMALL TREE WITH TREE PROTECTION (< 4" CAL.)
- EXISTING LARGE TREE WITH TREE PROTECTION
- PROPOSED DECIDUOUS SHADE TREE
- PROPOSED ORNAMENTAL TREE
- PROPOSED EVERGREEN TREE
- PROPOSED SHRUBS
- PROPOSED PERENNIALS, ORNAMENTAL GRASSES, & GROUNDCOVERS
- LAWN

NOTES:

- FOR PLANTING NOTES, REFER TO SHEET 230.
- FOR MASTER PLANT LIST, REFER TO SHEET 256.
- FOR LANDSCAPING DETAILS, REFER TO SHEETS 254-256.

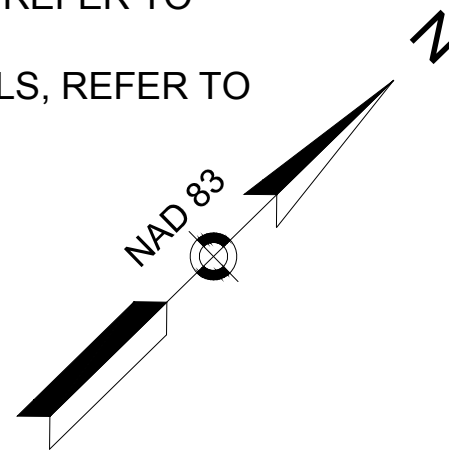

WATERTOWN
ROUTE 16 (MOUNT AUBURN STREET)

STATE	FED. AID PROJ. NO.	SHEET NO.	TOTAL SHEETS
MA	-	251	391

PROJECT FILE NO. 607777

LANDSCAPING ENLARGEMENT PLANS
SHEET 4 OF 6

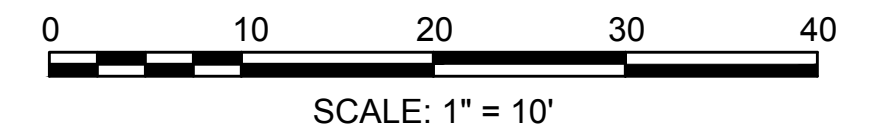

ENLARGEMENT 7 PLANT LIST

SYM	QTY	BOTANICAL NAME	COMMON NAME	SIZE	ROOT	COMMENTS
DECIDUOUS SHADE TREES						
PA	1	Platanus x acerifolia 'Exclamation'	Exclamation London Planetree	2.5-3" cal.	B&B	Limb to 7' ht.
ORNAMENTAL TREES						
SR	2	Syringa reticulata 'Ivory Silk'	Ivory Silk Japanese Tree Lilac	2.5-3" cal.	B&B	Single Stem
PERENNIALS, ORNAMENTAL GRASSES, & GROUNDCOVERS						
GR	52	Geranium x 'Rozanne'	Rozanne Hardy Geranium	1 gal.	CONT.	18" O.C. Spacing
HJ	74	Hemerocallis 'Joan Senior'	Joan Senior Daylily	1 gal.	CONT.	18" O.C. Spacing
PV	14	Panicum virgatum 'Shenandoah'	Shenandoah Switchgrass	2 gal.	CONT.	24" O.C. Spacing
PL	51	Perovskia atriplicifolia 'Little Spire'	Little Spire Russian Sage	1 gal.	CONT.	24" O.C. Spacing
SS	16	Schizachyrium scoparium 'Standing Ovation'	Little Bluestem	1 gal.	CONT.	18" O.C. Spacing

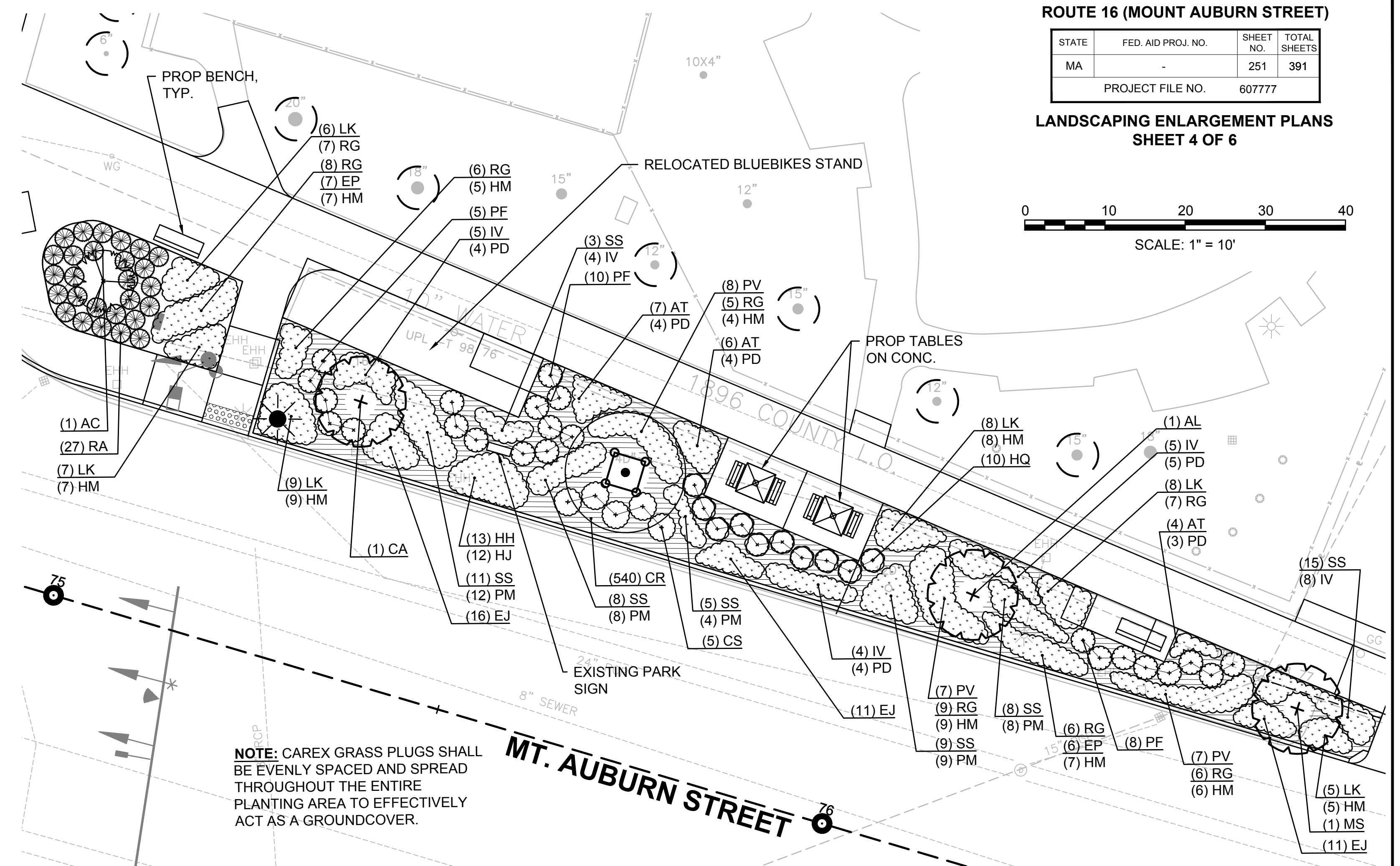

8 PLANTING AREA AT ARLINGTON STREET & MT. AUBURN STREET INTERSECTION
SCALE: 1"=10'-0"





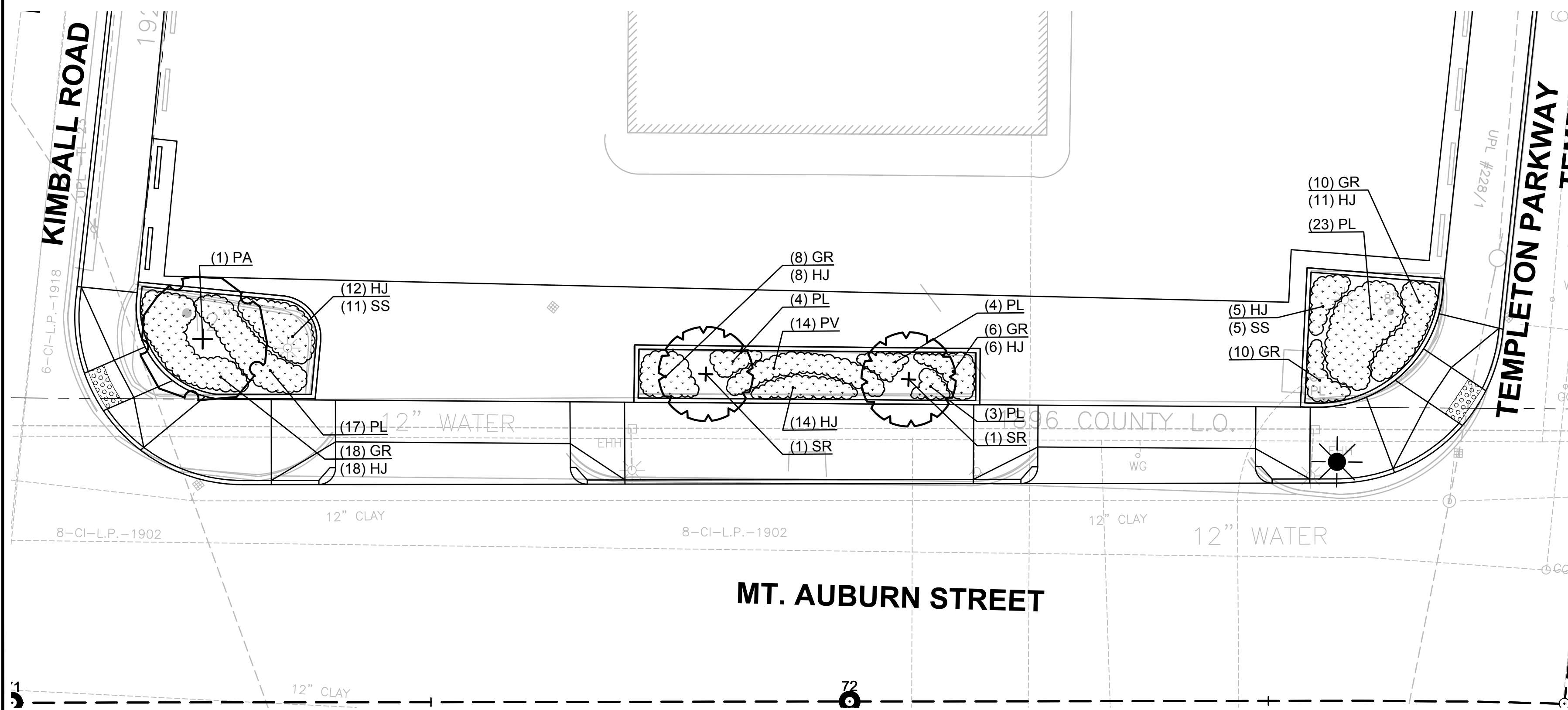



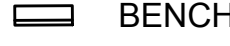

ENLARGEMENT 8 PLANT LIST

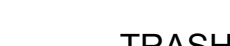
SYM	QTY	BOTANICAL NAME	COMMON NAME	SIZE	ROOT	COMMENTS
EVERGREEN TREES						
AC	1	Abies concolor	White Fir	7-8' ht.	B&B	
ORNAMENTAL TREES						
AL	1	Amelanchier laevis 'Snowcloud'	Snowcloud Serviceberry	2.5-3" cal.	B&B	Single Stem
CA	1	Cornus 'Aurora'	Aurora Dogwood	2.5-3" cal.	B&B	
MS	1	Malus 'Spring Snow'	Spring Snow Crabapple	2.5-3" cal.	B&B	Fruitless variety
SHRUBS						
CS	5	Cornus sericea 'Arctic Fire'	Arctic Fire Red Twig Dogwood	18-24" ht.	CONT.	
HQ	7	Hydrangea quercifolia 'Pee Wee'	Pee Wee Oakleaf Hydrangea	18-24" ht.	CONT.	
PF	23	Potentilla fruticosa 'Pink Beauty'	Pink Beauty Shrubby Cinquefoil	18-24" ht.	CONT.	
RA	27	Rhus aromatica 'Gro-Low'	Gro-Low Fragrant Sumac	2 gal.	CONT.	30" O.C. Spacing
PERENNIALS, ORNAMENTAL GRASSES, & GROUNDCOVERS						
AT	17	Amsonia tabernaemontana 'Blue Ice'	Blue Ice Blue Star Flower	1 gal.	CONT.	18" O.C. Spacing
CR	540	Carex amphiploba	Creek Sedge		PLUG	12" O.C. Spacing
EP	13	Echinacea purpurea 'Magnus'	Magnus Purple Coneflower	1 gal.	CONT.	18" O.C. Spacing
EJ	38	Eutrochium dubium 'Little Joe'	Little Joe Joe Pye Weed	1 gal.	CONT.	18" O.C. Spacing
HM	67	Helenium 'Mardi Gras'	Mardi Gras Sneezeweed	1 gal.	CONT.	18" O.C. Spacing
HJ	13	Hemerocallis 'Happy Returns'	Happy Returns Daylily	1 gal.	CONT.	18" O.C. Spacing
HJ	12	Hemerocallis 'Joan Senior'	Joan Senior Daylily	1 gal.	CONT.	18" O.C. Spacing
IV	26	Iris versicolor	Blue Flag Iris	1 gal.	CONT.	24" O.C. Spacing
LK	43	Liatris spicata 'Kobold'	Kobold Blazing Star	1 gal.	CONT.	18" O.C. Spacing
PV	22	Panicum virgatum 'Shenandoah'	Shenandoah Switchgrass	1 gal.	CONT.	24" O.C. Spacing
PD	24	Penstemon digitalis	Beardtongue	1 gal.	CONT.	24" O.C. Spacing
PM	41	Pycnanthemum muticum	Mountain Mint	1 gal.	CONT.	18" O.C. Spacing
RG	53	Rudbeckia fulgida 'Goldsturm'	Goldsturm Black-Eyed Susan	1 gal.	CONT.	18" O.C. Spacing
SS	59	Schizachyrium scoparium 'Standing Ovation'	Little Bluestem	1 gal.	CONT.	18" O.C. Spacing

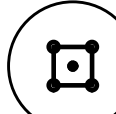

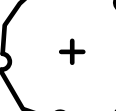
7 PLANTING AREA AT KIMBALL ROAD & MT. AUBURN STREET INTERSECTION
SCALE: 1"=10'-0"

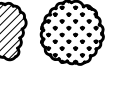
LEGEND

-  BENCH
-  TABLE
-  TRASH RECEPTACLE TYPE A
-  TRASH RECEPTACLE TYPE B
-  BICYCLE PARKING POST
-  EXISTING SMALL TREE WITH TREE PROTECTION (< 4" CAL.)
-  EXISTING LARGE TREE WITH TREE PROTECTION
-  PROPOSED DECIDUOUS SHADE TREE
-  PROPOSED ORNAMENTAL TREE
-  PROPOSED EVERGREEN TREE
-  PROPOSED SHRUBS
-  PROPOSED PERENNIALS, ORNAMENTAL GRASSES, & GROUNDCOVERS
-  LAWN

NOTES:

1. FOR PLANTING NOTES, REFER TO SHEET 230.
2. FOR MASTER PLANT LIST, REFER TO SHEET 256.
3. FOR LANDSCAPING DETAILS, REFER TO SHEETS 254-256.

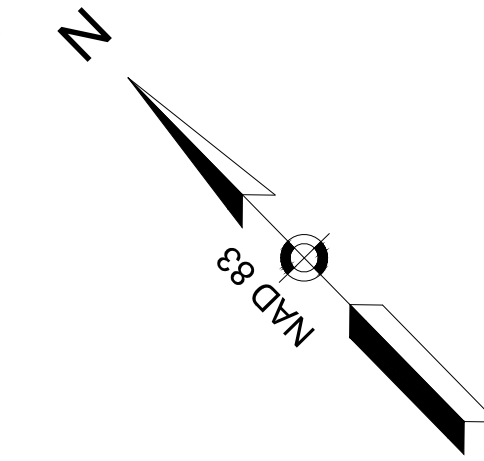

**WATERTOWN
ROUTE 16 (MOUNT AUBURN STREET)**

STATE	FED. AID PROJ. NO.	SHEET NO.	TOTAL SHEETS
MA	-	252	391
PROJECT FILE NO.		607777	

**LANDSCAPING ENLARGEMENT PLANS
SHEET 5 OF 6**



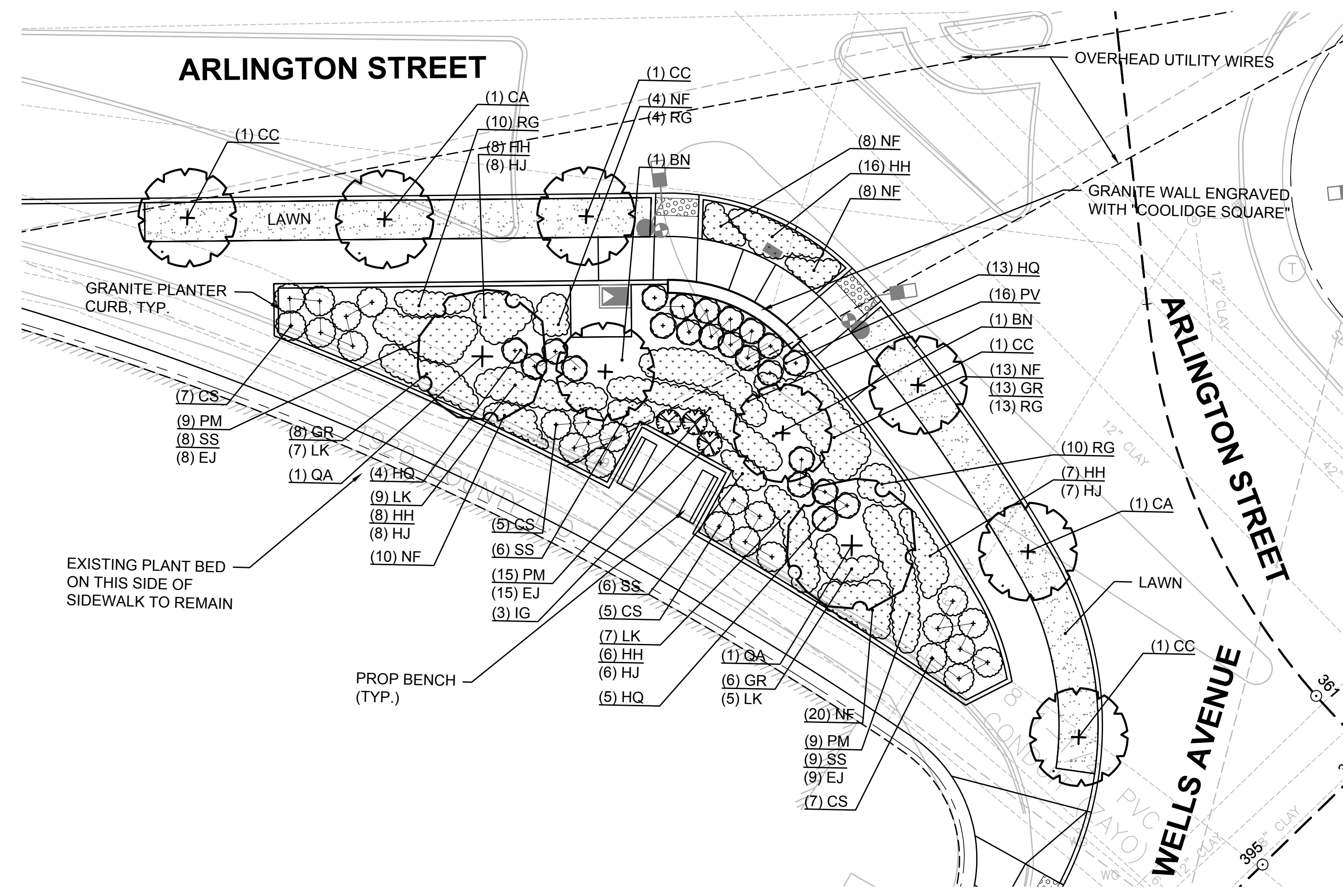

ENLARGEMENT 9 PLANT LIST

SYM	QTY	BOTANICAL NAME	COMMON NAME	SIZE	ROOT	COMMENTS
DECIDUOUS SHADE TREES						
QA	2	Quercus alba	White Oak	2.5-3" cal.	B&B	Limb to 7' ht.
ORNAMENTAL TREES						
BN	2	Betula nigra 'Heritage'	Heritage River Birch	2.5-3" cal.	B&B	Single stem
CC	4	Cercis canadensis	Eastern Redbud	2.5-3" cal.	B&B	Single stem
CA	2	Cornus 'Aurora'	Aurora Dogwood	2.5-3" cal.	B&B	
SHRUBS						
CS	24	Cornus sericea 'Arctic Fire'	Arctic Fire Red Twig Dogwood	18-24" ht.	CONT.	
HQ	22	Hydrangea quercifolia 'Pee Wee'	Pee Wee Oakleaf Hydrangea	18-24" ht.	CONT.	
IG	3	Ilex glabra 'Shamrock'	Shamrock Inkberry	24-30" ht.	CONT.	
PERENNIALS, ORNAMENTAL GRASSES, & GROUNDCOVERS						
EJ	32	Eutrochium dubium 'Little Joe'	Little Joe Joe Pye Weed	1 gal.	CONT.	18" O.C. Spacing
GR	27	Geranium x 'Rozanne'	Rozanne Hardy Geranium	1 gal.	CONT.	18" O.C. Spacing
HH	45	Hemerocallis 'Happy Returns'	Happy Returns Daylily	1 gal.	CONT.	18" O.C. Spacing
HJ	29	Hemerocallis 'Joan Senior'	Joan Senior Daylily	1 gal.	CONT.	18" O.C. Spacing
LK	29	Liatris spicata 'Kobold'	Kobold Blazing Star	1 gal.	CONT.	18" O.C. Spacing
NF	63	Nepeta x faassenii 'Junior Walker'	Junior Walker Catmint	1 gal.	CONT.	18" O.C. Spacing
PV	16	Panicum virgatum 'Shenandoah'	Shenandoah Switchgrass	2 gal.	CONT.	24" O.C. Spacing
PM	33	Pycnanthemum muticum	Mountain Mint	1 gal.	CONT.	18" O.C. Spacing
RG	37	Rudbeckia fulgida 'Goldsturm'	Goldsturm Black-Eyed Susan	1 gal.	CONT.	18" O.C. Spacing
SS	29	Schizachyrium scoparium 'Standing Ovation'	Little Bluestem	1 gal.	CONT.	18" O.C. Spacing

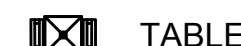
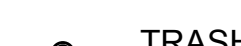

9 PLANTING AREA AT ARLINGTON STREET & WELLS AVENUE INTERSECTION
SCALE: 1"=10'-0"

LEGEND

-  BENCH
-  TABLE
-  TRASH RECEPTACLE TYPE A
-  TRASH RECEPTACLE TYPE B
-  BICYCLE PARKING POST

PLANTER CURB LAYOUT NOTES:

1. ALL LINES AND DIMENSIONS ARE PARALLEL OR PERPENDICULAR TO THE LINES FROM WHICH THEY ARE MEASURED UNLESS OTHERWISE NOTED.
2. ALL DIMENSIONS ARE FROM FACE OF VERTICAL CURB, WALL, OR BUILDING OR CENTERLINE OF PAVEMENT UNLESS OTHERWISE NOTED.
3. THE DIMENSIONS SHOWN ON THE DRAWINGS SHOW DESIGN INTENT AND MUST BE FIELD VERIFIED PRIOR TO PREPARATION OF SHOP DRAWINGS. SHOP DRAWINGS SHALL BE BASED UPON ACTUAL LAYOUT AND FIELD MEASUREMENT BY THE CONTRACTOR.
4. ALL PROPOSED PLANTER CURBING SHALL BE LAID OUT AND STAKED BY THE CONTRACTOR FOR REVIEW AND APPROVAL BY THE OWNER'S REPRESENTATIVE. ANY REQUIRED ADJUSTMENTS TO THE LAYOUT SHALL BE UNDERTAKEN BY THE CONTRACTOR AT NO ADDITIONAL COST TO THE OWNER.

**WATERTOWN
ROUTE 16 (MOUNT AUBURN STREET)**

STATE	FED. AID PROJ. NO.	SHEET NO.	TOTAL SHEETS
MA	-	253	391
PROJECT FILE NO.		607777	

**LANDSCAPING ENLARGEMENT PLAN
SHEET 6 OF 6**

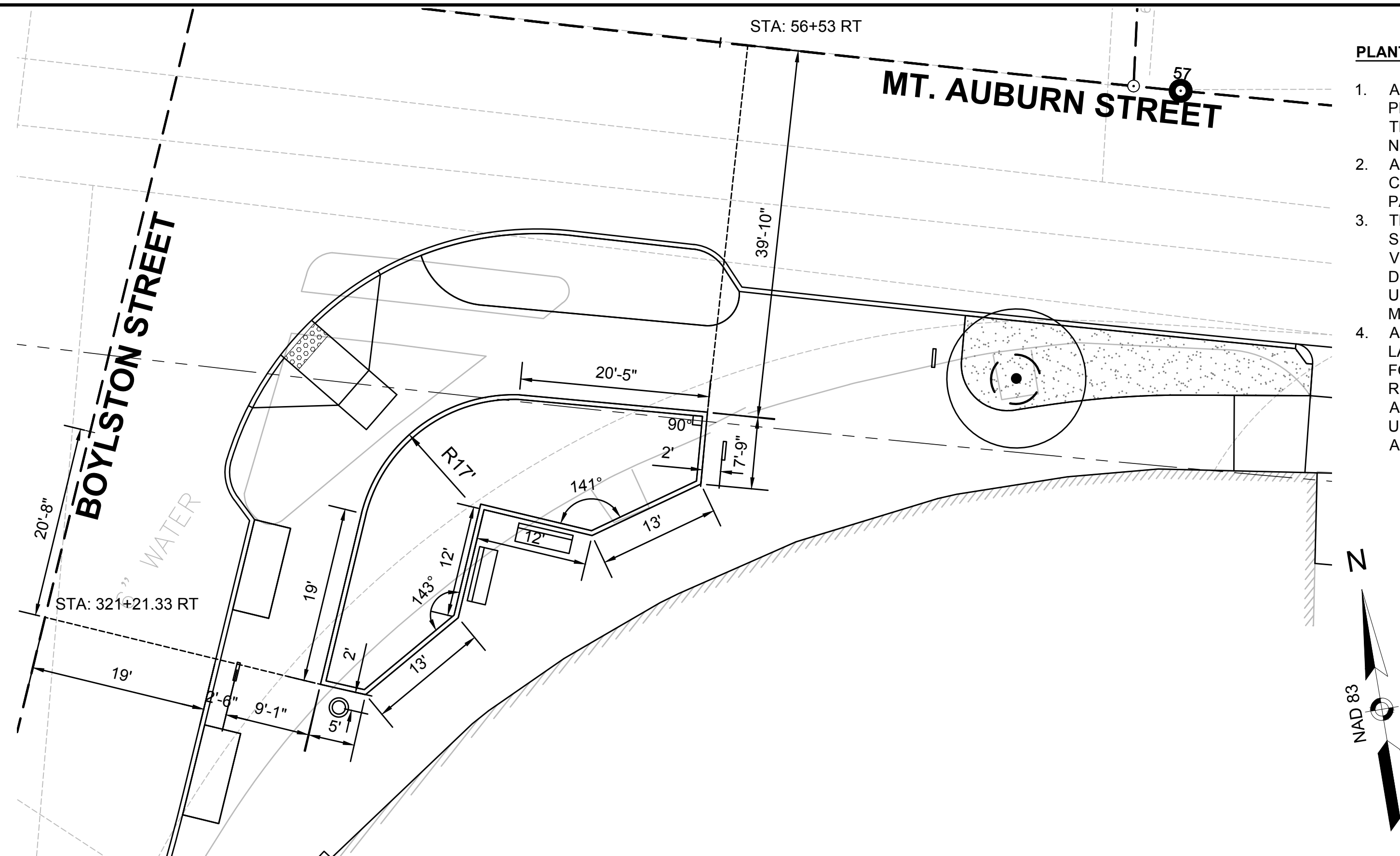
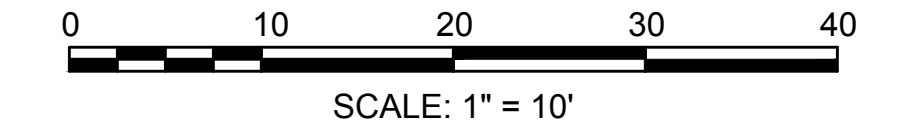

1 PLANTER CURB LAYOUT AT BOYLSTON STREET & MT. AUBURN STREET INTERSECTION (WEST)
SCALE: 1"=10'-0"

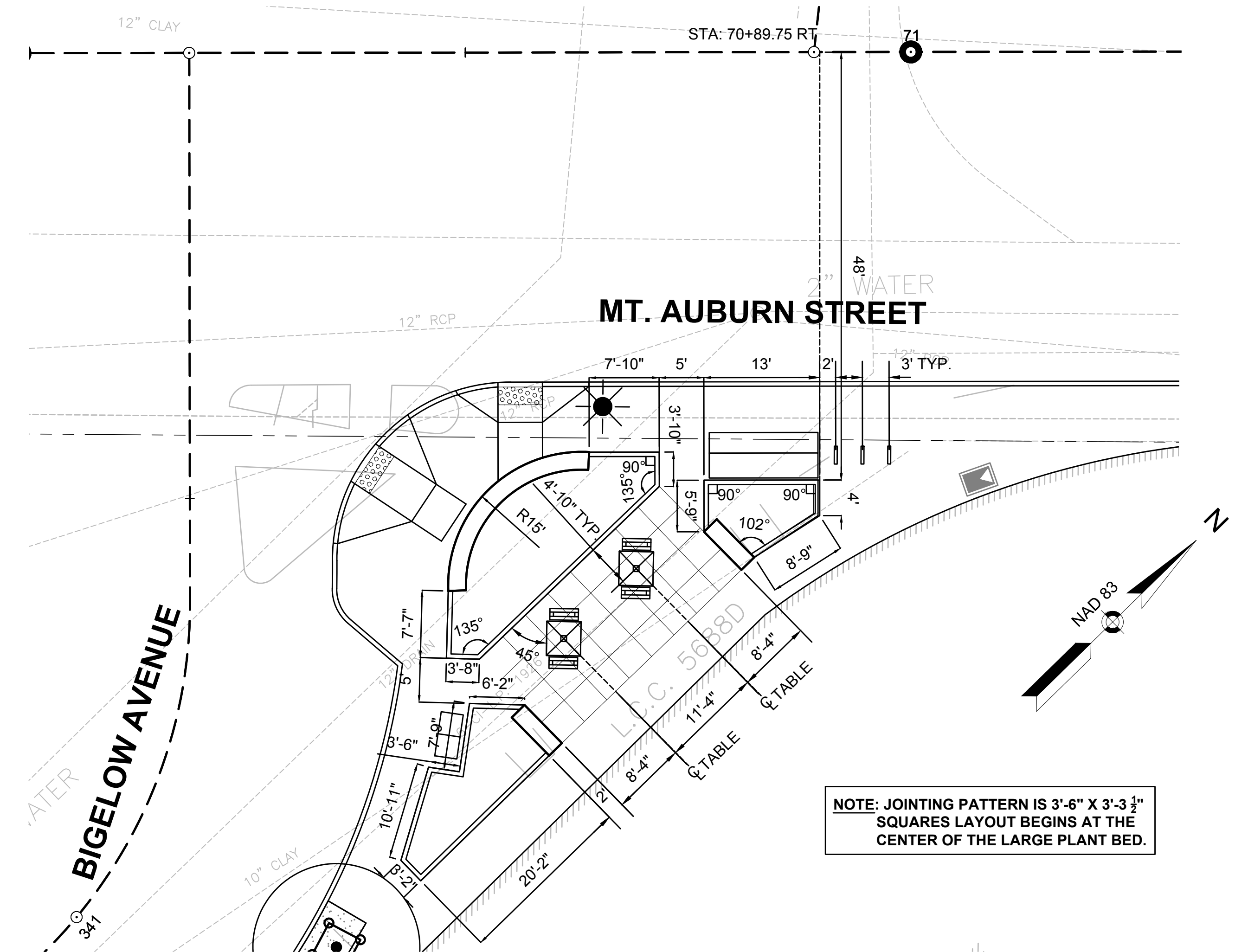

NOTE: JOINTING PATTERN IS 3'-6" X 3'-3 1/2"
SQUARES LAYOUT BEGINS AT THE
CENTER OF THE LARGE PLANT BED.

2 PLANTER CURB LAYOUT AT BIGELOW AVENUE & MT. AUBURN STREET INTERSECTION
SCALE: 1"=10'-0"

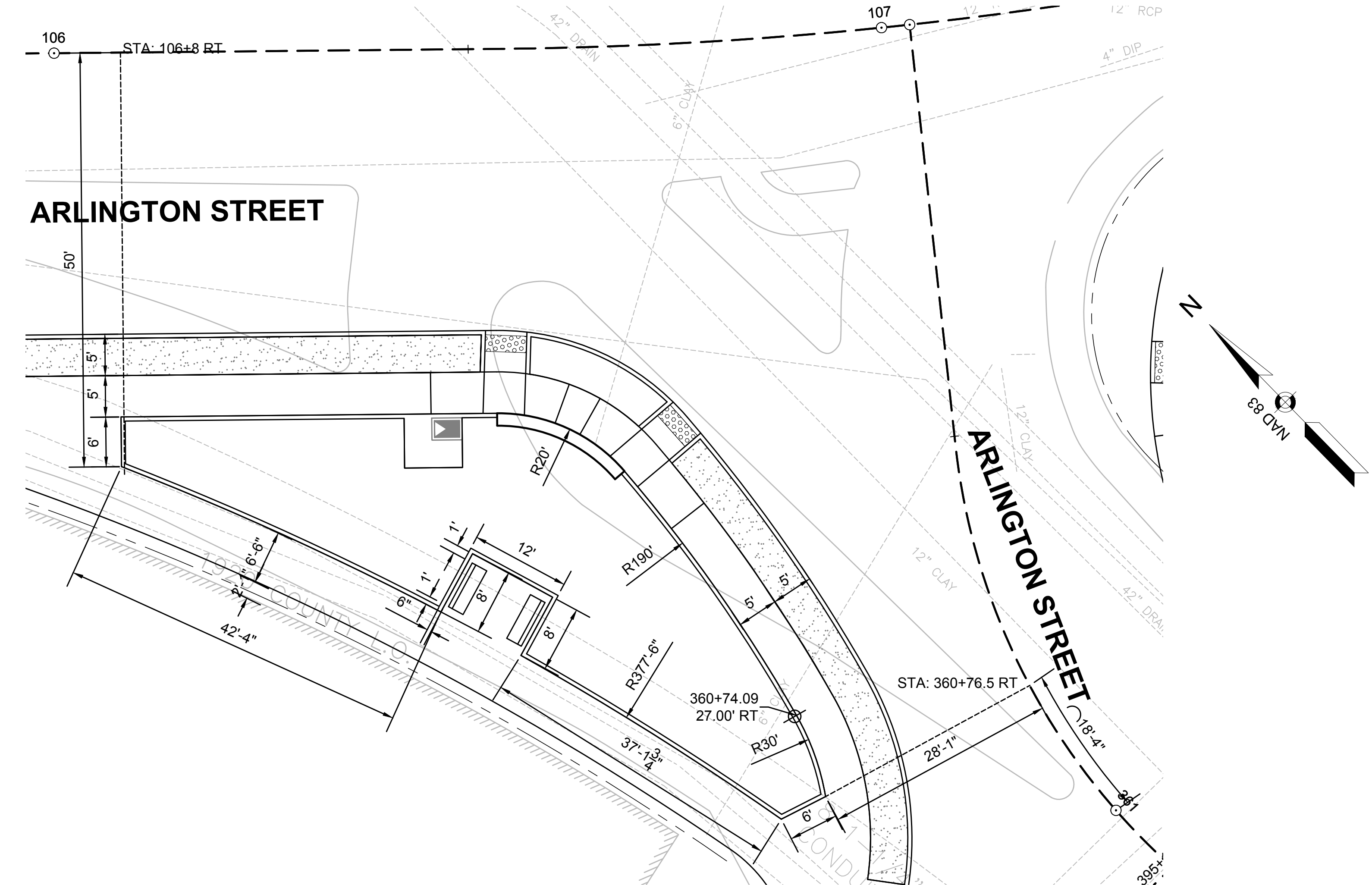

3 PLANTER CURB LAYOUT AT ARLINGTON STREET & WELLS AVENUE INTERSECTION
SCALE: 1"=10'-0"

STATE	FED. AID PROJ. NO.	SHEET NO.	TOTAL SHEETS
MA	-	254	391
PROJECT FILE NO.		607777	

EXCAVATE TO REQUIRED DEPTH AND BACKFILL WITH PLANTING MIX

RAISE AND REPLANT PLANTS THAT SETTLE MORE THAN 3 INCHES AFTER PLANTING AND WATERING IN WATER BY FLOODING TWICE IN FIRST TWO HOURS AFTER PLANTING. WATER & MAINTAIN AS PER STANDARD SPECIFICATIONS

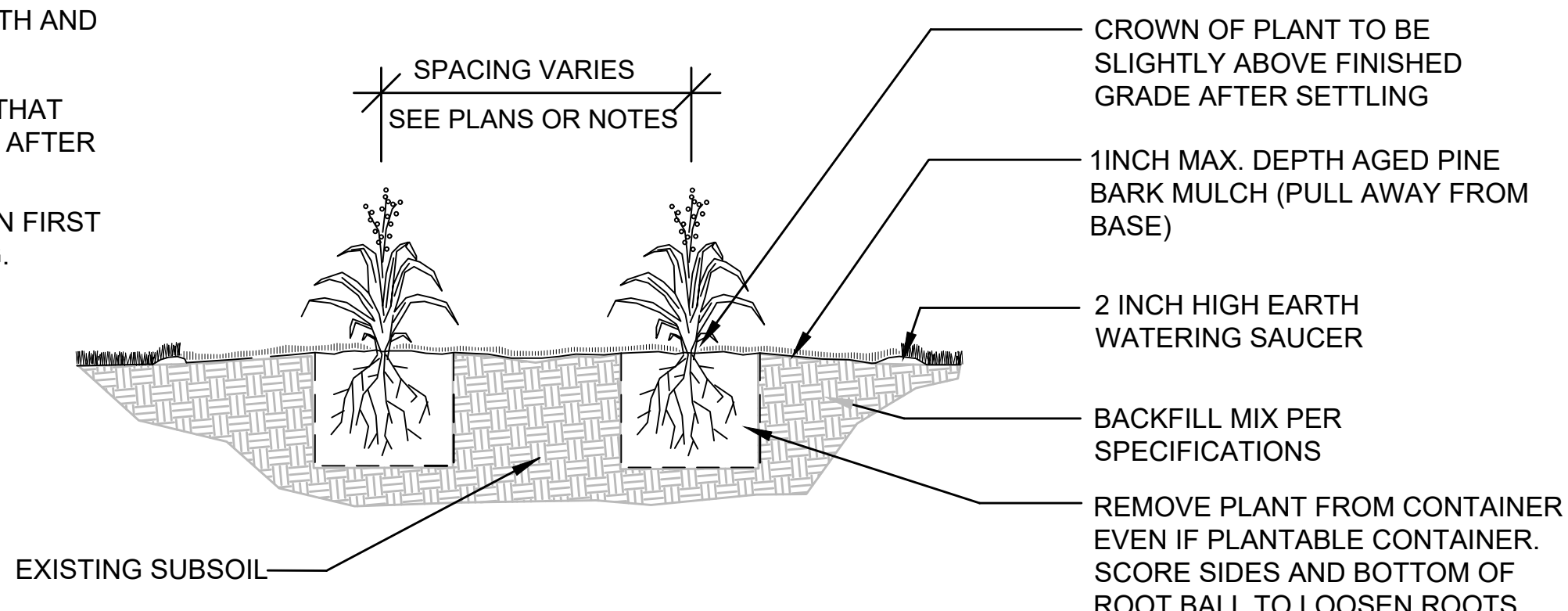

PERENNIAL / ORNAMENTAL GRASS PLANTING

NOT TO SCALE

PLUGS SHALL BE STAGGERED 12" ON CENTER AND INTERSPERSED AMONG POTTED PERENNIALS AND ORNAMENTAL GRASSES.

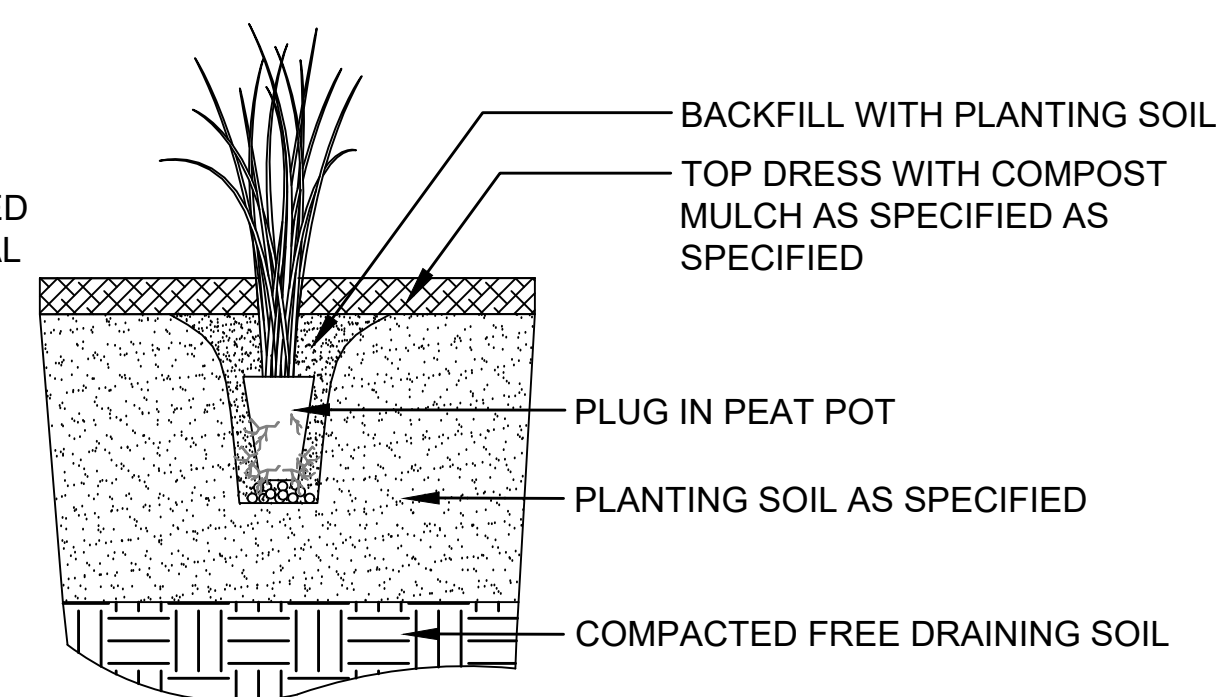

PLUG PLANTING

NOT TO SCALE

EXCAVATE TO REQUIRED DEPTH AND BACKFILL WITH PLANTING MIX
SHRUBS SHALL BE SET PLUMB

WATER BY FLOODING TWICE IN FIRST TWO HOURS AFTER PLANTING. WATER & MAINTAIN AS PER STANDARD SPECIFICATIONS
CROWN OF SHRUB SHOULD BE SLIGHTLY ABOVE FINISHED GRADE AFTER SETTLING

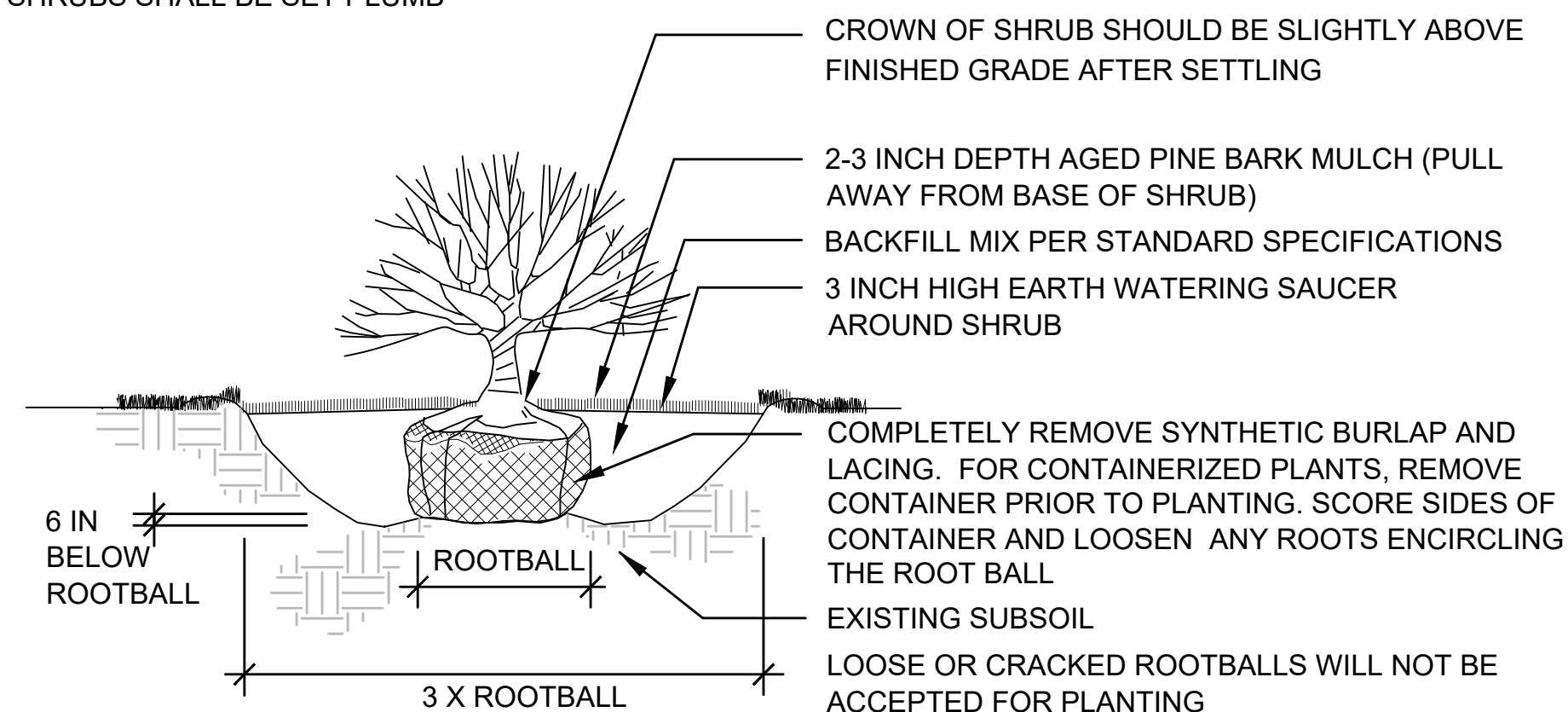

SHRUB PLANTING

NOT TO SCALE

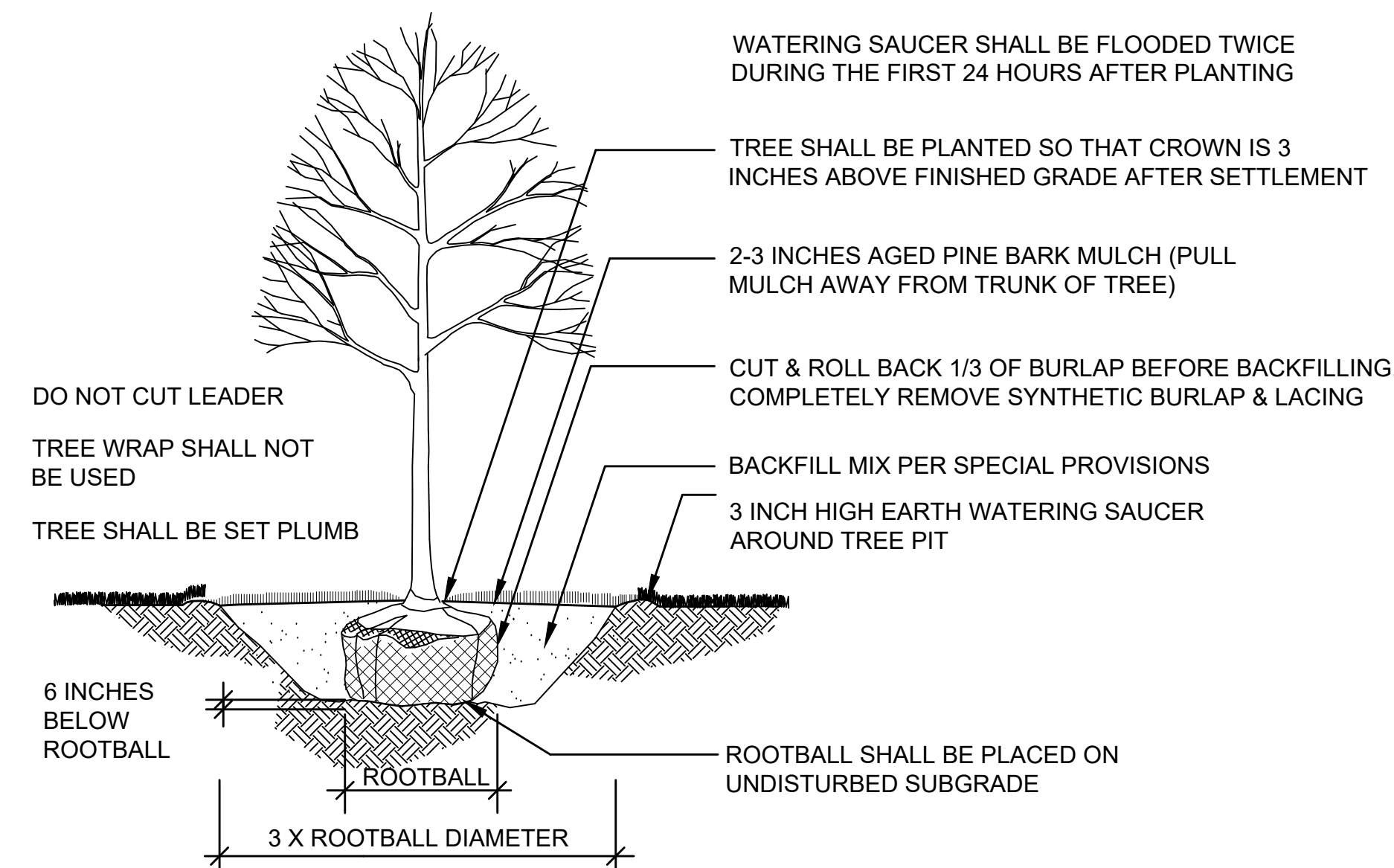

DECIDUOUS TREE PLANTING

NOT TO SCALE

WATERING SAUCER SHALL BE FLOODED TWICE DURING THE FIRST 24 HOURS AFTER PLANTING

TREE SHALL BE SET PLUMB DO NOT CUT LEADER

TREE SHALL BE PLANTED SO THAT CROWN IS 3 INCHES ABOVE FINISHED GRADE AFTER SETTLEMENT

2-3" AGED PINE BARK MULCH (PULL MULCH AWAY FROM TRUNK OF TREE)

BACKFILL MIX PER SPECIAL PROVISIONS

3 INCH HIGH EARTH WATERING SAUCER AROUND TREE PIT

EVERGREEN TREE PLANTING

NOT TO SCALE

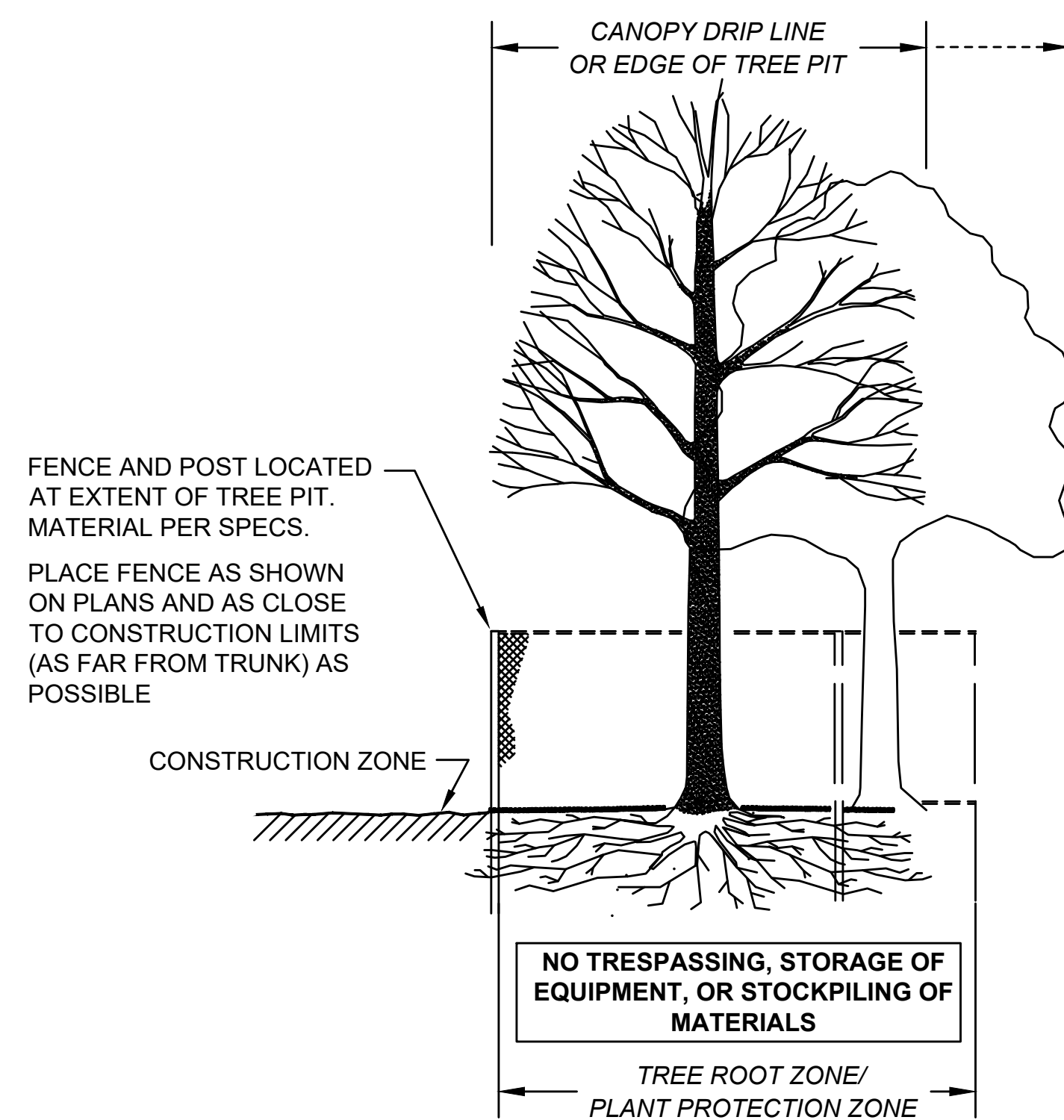
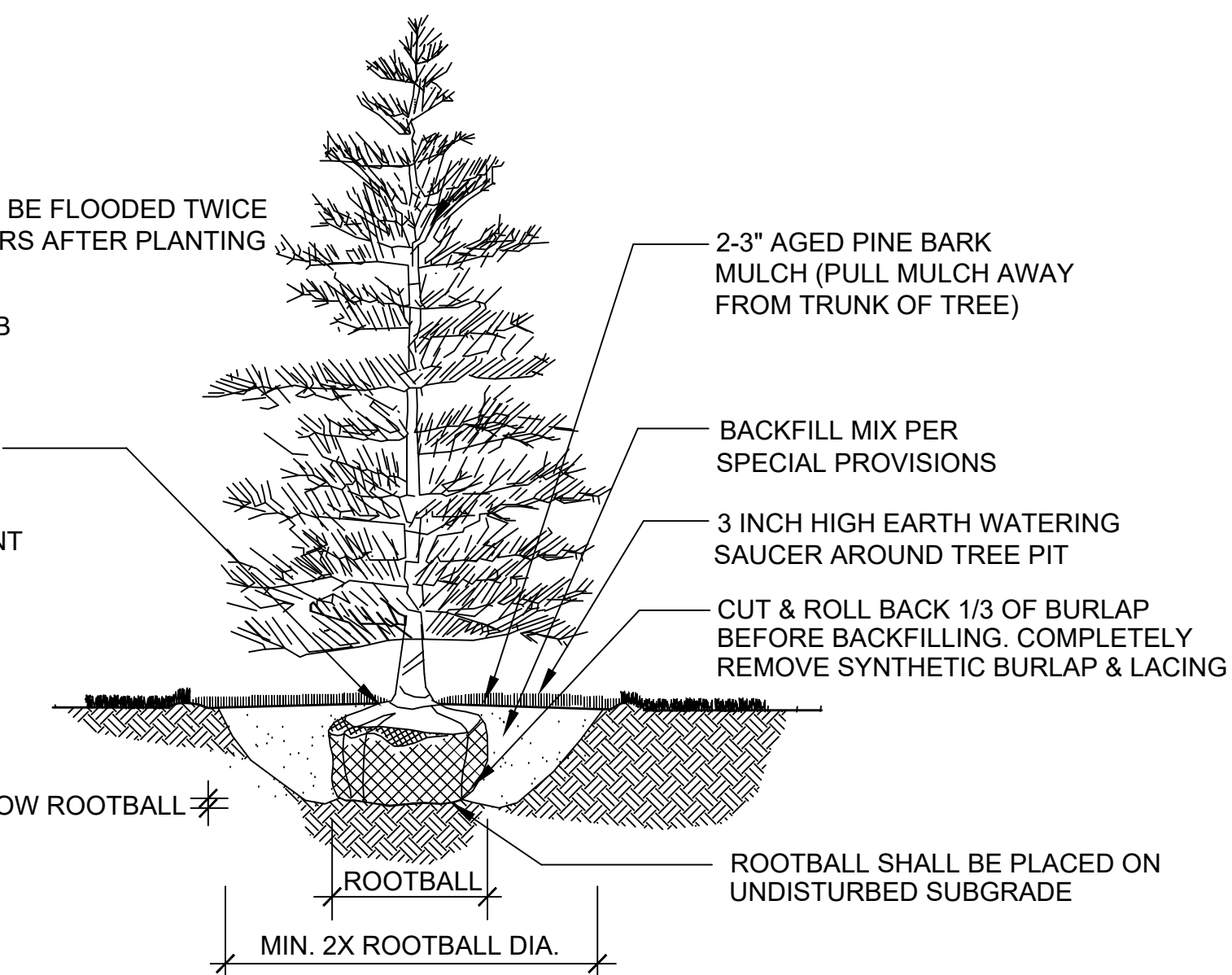

SECTION - FENCE PROTECTION OF ROOT ZONE

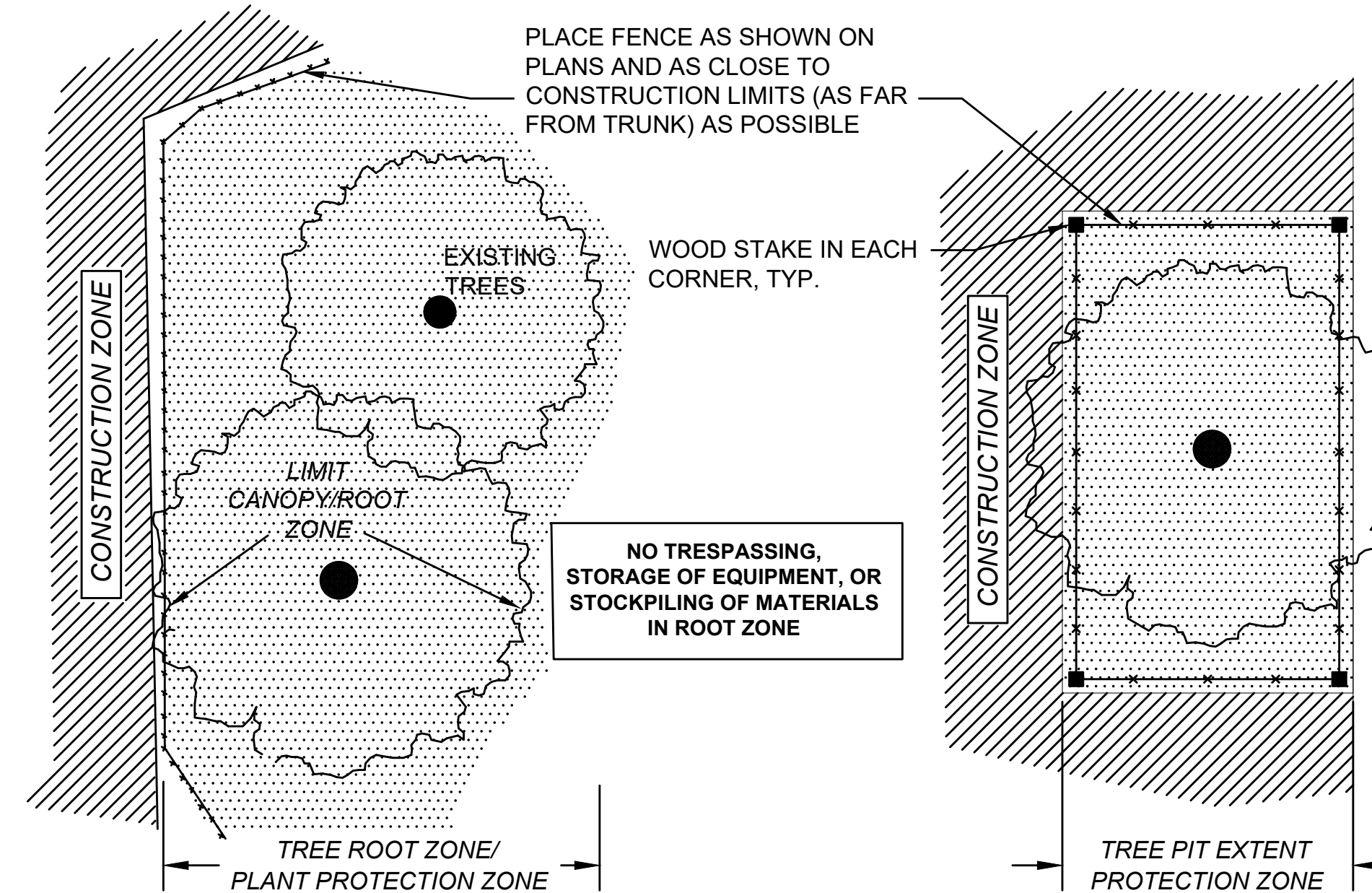

PLAN VIEW - TREES IN LANDSCAPE OR < 4" CAL.

PLAN VIEW - TREES IN TREE PIT

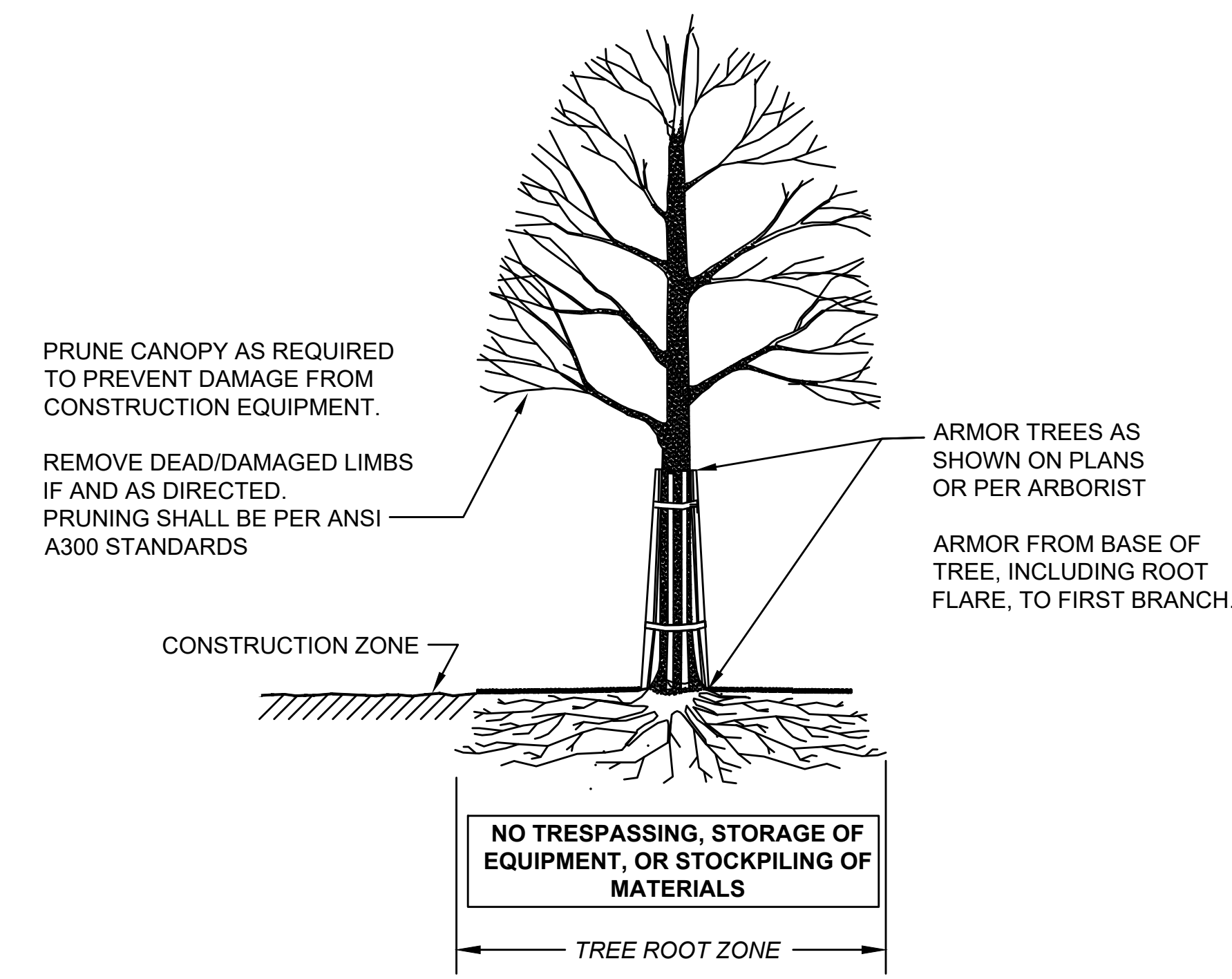

SECTION - TRUNK ARMORING & PRUNING FOR TREES > 4" CAL.

TREE PROTECTION - ROOT ZONE & TRUNK ARMORING

SCALE: N.T.S.

STATE	FED. AID PROJ. NO.	SHEET NO.	TOTAL SHEETS
MA	-	255	391
PROJECT FILE NO.		607777	

EXISTING STREET TREE NOTES:

- FOR EXISTING TREES IN EXPANDED TREE PITS, INSTALL ADDITIONAL PLANTING SOIL TO THE NEW LIMITS OF THE TREE PIT AND TO A 2' DEPTH.
- INSTALL COMPOST MULCH AT EXISTING TREES TO THE LIMITS OF THE NEW TREE PIT.

TYPICAL TREE PLANTING NOTES:

- COMPOST MULCH SHALL BE INSTALLED IN ALL TREE PITS TO THE LIMITS OF THE TREE PIT.
- REFER TO PERENNIAL / ORNAMENTAL GRASS PLANTING DETAIL AND PLUG PLANTING DETAIL FOR PROPOSED UNDERPLANTING AT TREES.

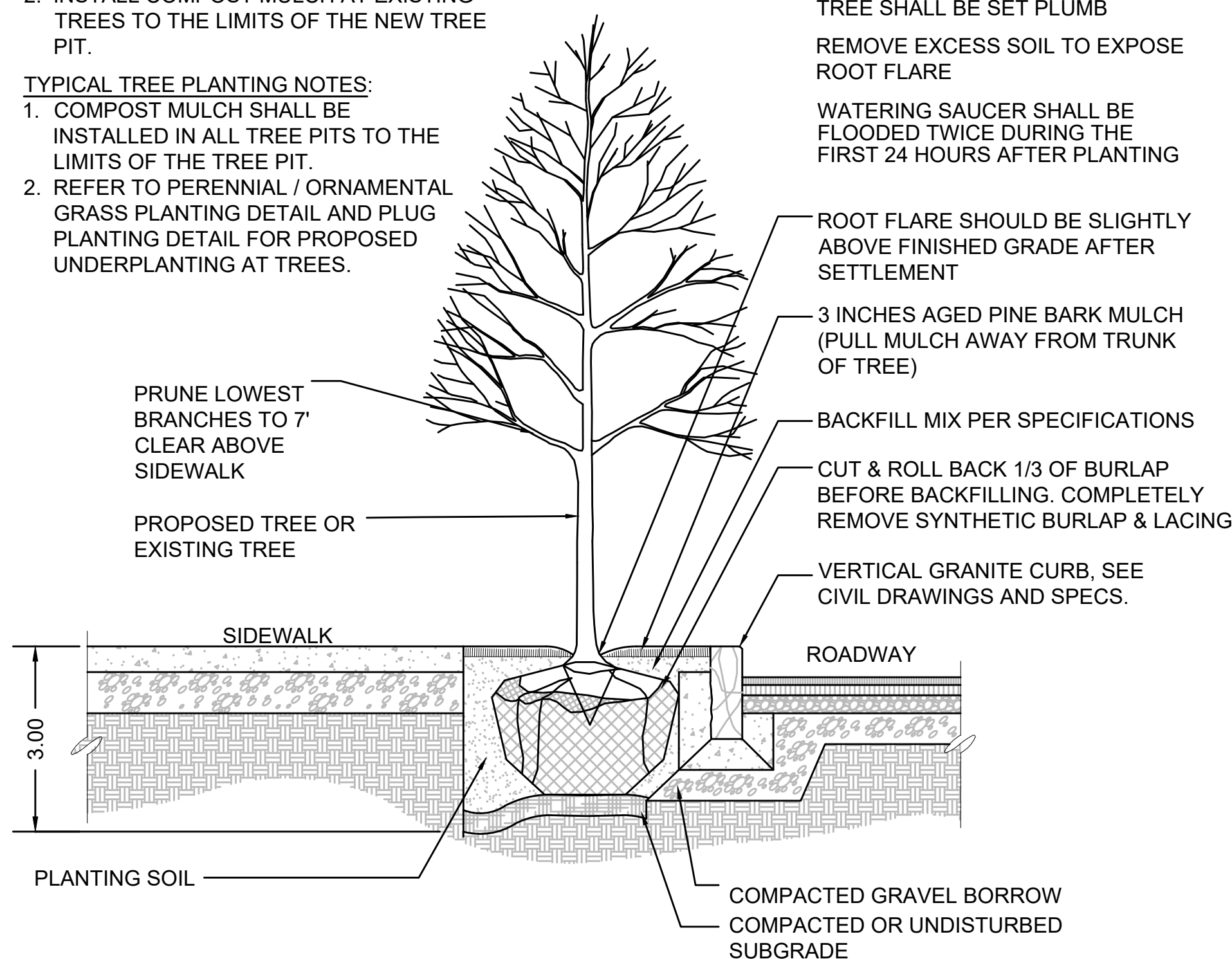

DECIDUOUS TREE PLANTING IN TREE PIT

NOT TO SCALE

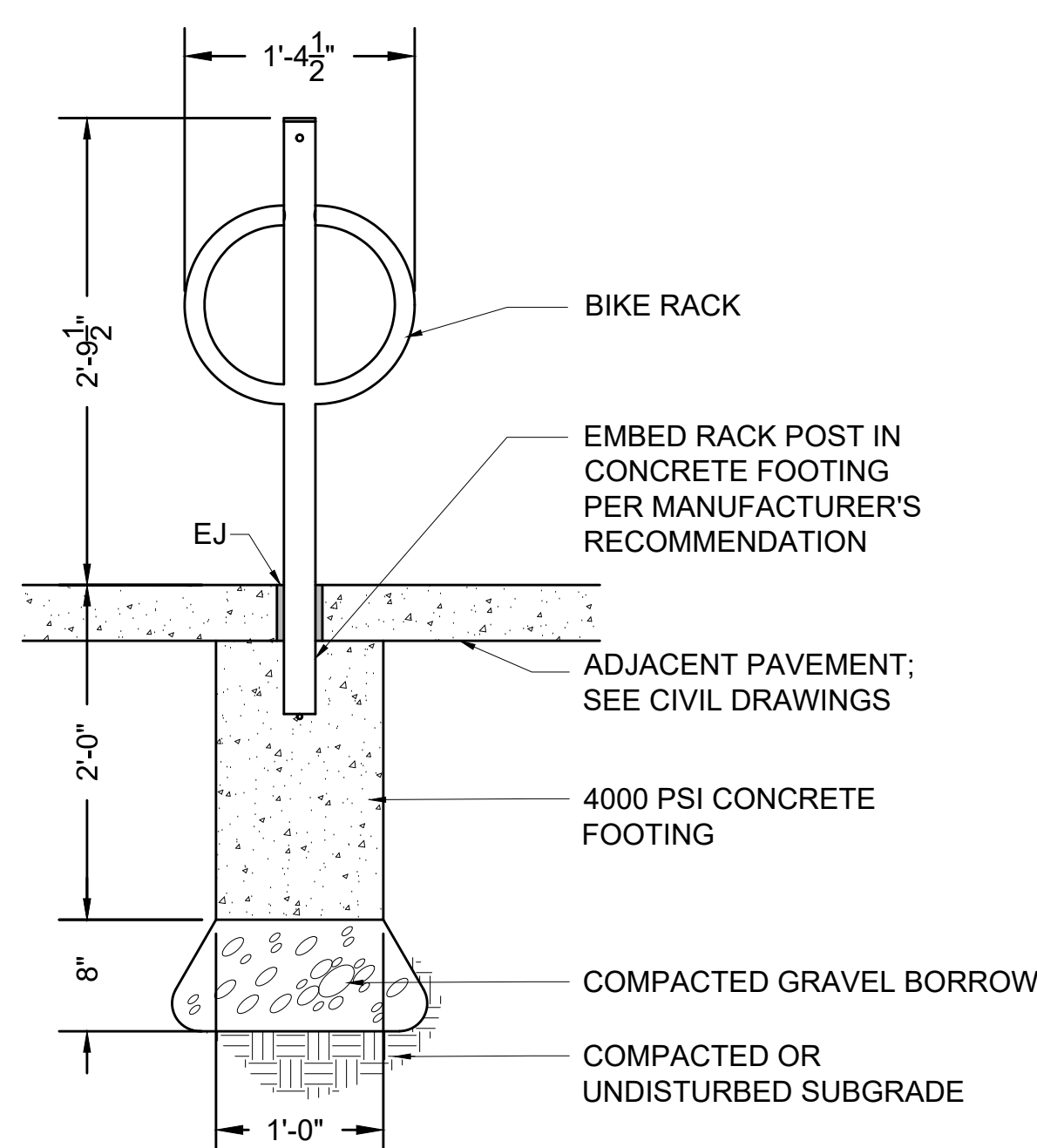

BIKE RACK

SCALE: 1" = 1'-0"

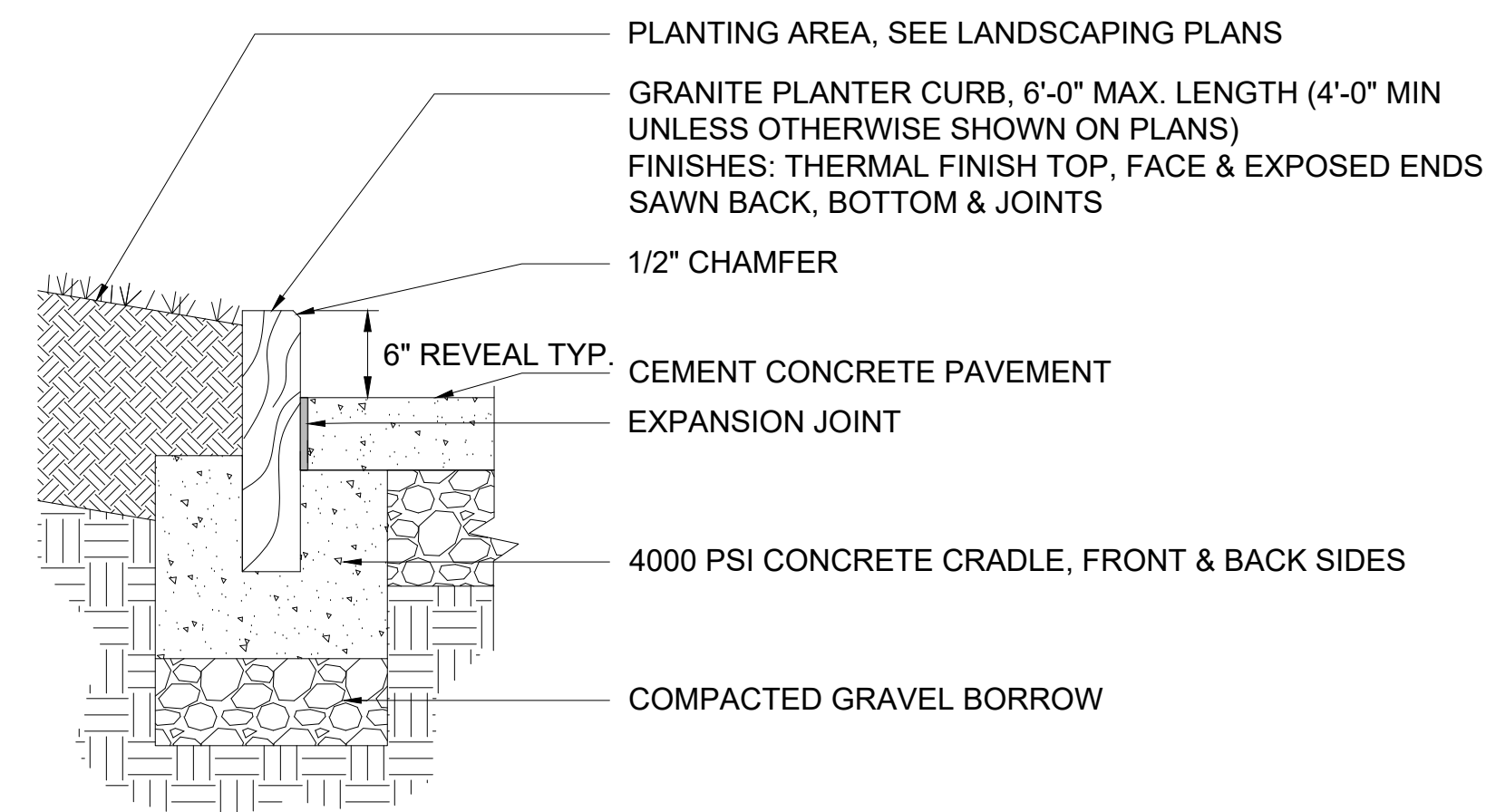

PLANTER CURB

SCALE: 1" = 1'-0"

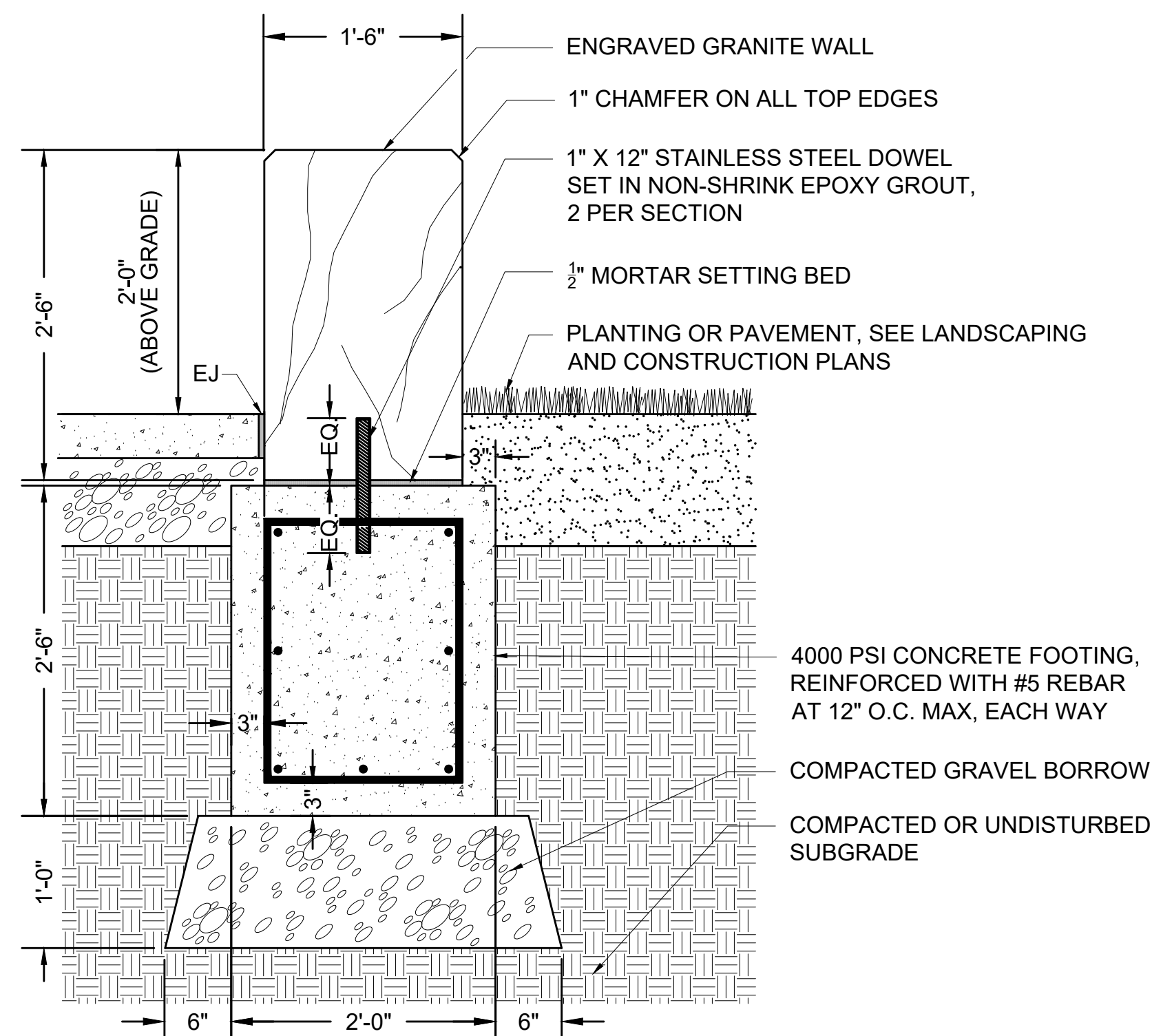

GRANITE BLOCK SEAT:

- SEAT SHALL BE SINGLE MONOLITHIC GRANITE BLOCK.
- BLOCK DIMENSIONS AND SETTING SHALL MATCH DETAILS HERE, EXCEPT BLOCK HEIGHT SHALL BE 1' - 6" ABOVE FINISHED GRADE.
- BLOCK SEAT SHALL BE ANCHORED WITH TWO STAINLESS STEEL DOWELS, PER SECTION DETAIL.
- BLOCK SEAT SHALL NOT BE ENGRAVED.

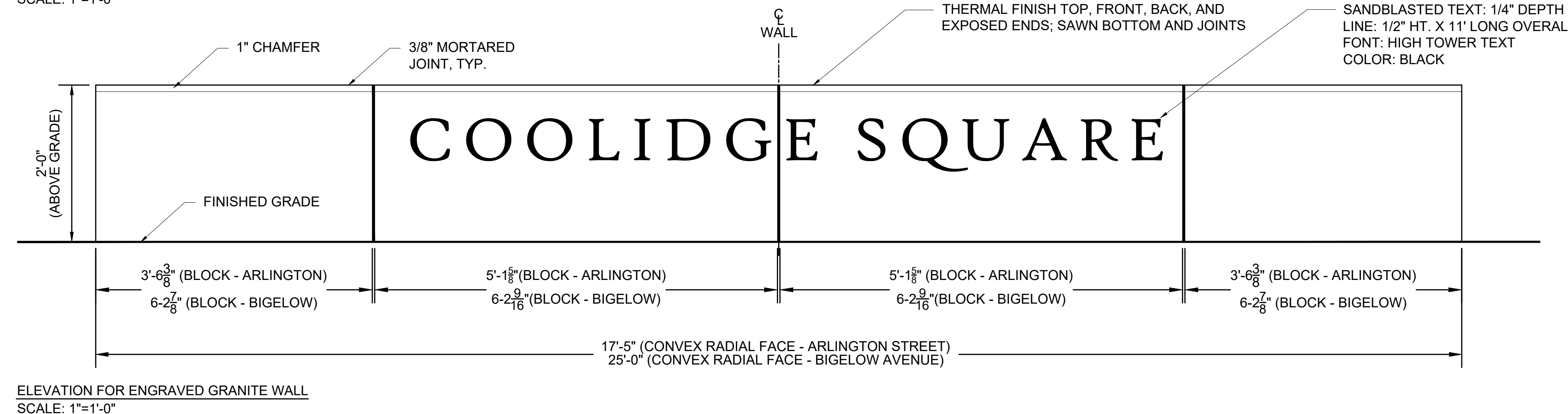
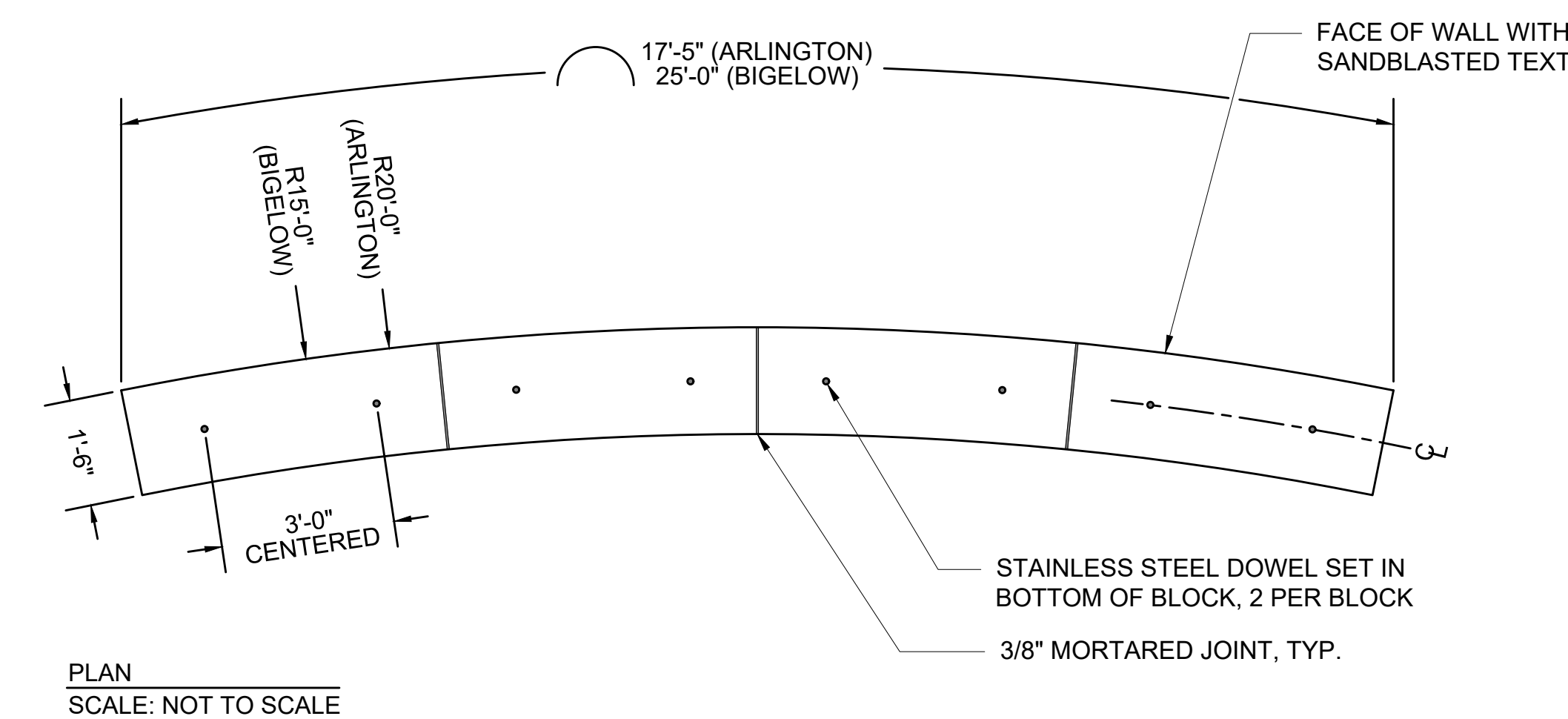

ENGRAVED GRANITE WALL & GRANITE BLOCK SEAT

SCALE: AS NOTED

